

GLOBAL NAVIGATION SATELLITE SYSTEM

GLONASS



INTERFACE
CONTROL
DOCUMENT

Navigational radiosignal
In bands L1, L2

(Edition 5.1)

MOSCOW
2008

FIGURES	5
TABLES	5
1. INTRODUCTION.....	8
1.1 GLONASS PURPOSE.....	8
1.2 GLONASS COMPONENTS	8
1.3 NAVIGATION DETERMINATION CONCEPT	9
2. GENERAL	10
2.1 ICD DEFINITION	10
2.2 ICD APPROVAL AND REVISION	10
3. REQUIREMENTS.....	12
3.1 INTERFACE DEFINITION.....	12
3.2 NAVIGATION SIGNAL STRUCTURE.....	12
3.2.1 Ranging code	13
3.2.2 Digital data of navigation message.....	13
3.3 INTERFACE DESCRIPTION	13
3.3.1 Navigation RF signal characteristics	13
3.3.2 Modulation.....	17
3.3.3 GLONASS time	22
3.3.4 Coordinate system.....	23
4. NAVIGATION MESSAGE.....	25
4.1 NAVIGATION MESSAGE PURPOSE	25
4.2 NAVIGATION MESSAGE CONTENT	25
4.3 NAVIGATION MESSAGE STRUCTURE.....	25
4.3.1 Superframe structure.....	26
4.3.2 Frame structure	27
4.3.3 String structure.....	29
4.4 IMMEDIATE INFORMATION AND EPHEMERIS PARAMETERS	30
4.5 NON-IMMEDIATE INFORMATION AND ALMANAC	36
4.6 RESERVED BITS	41
4.7 DATA VERIFICATION ALGORITHM.....	42
5 GLONASS SPACE SEGMENT	43
5.1 CONSTELLATION STRUCTURE	43
5.2 ORBITAL PARAMETERS	44
5.3 INTEGRITY MONITORING.....	45
RECEIVED POWER LEVEL IN L1 AND L2 SUB-BANDS.....	46
APPENDIX 2	48

RECOMMENDATIONS FOR USERS ON OPERATION OF RECEIVER DURING UTC LEAP SECOND CORRECTION	48
APPENDIX 3	50

FIGURES

	page
Fig. 3.1 Interface NKA/NAP	14
Fig. 3.2 Structure of the shift register shaping a ranging code	20
Fig. 3.3 Simplified block diagramme of PSPD ranging creation code and sync signals for a navigational radiosignal	21
Fig. 3.4 Simplified block diagramme of data creation series	21
Fig. 3.5 T Temporal ratio between sync signals of a modulating navigational signal and PSPD ranging code	22
Fig. 3.6 Data series creation in NKA processor	22
Fig. 4.1 Superframe structure	29
Fig. 4.2 Frame structure	31
Fig. 4.3 String structure	32
Fig. of Item 1 Relation between the radiosignal amplifying underpower and elevation angle	52

TABLES

	page
Table 3.1 GLONASS carrier frequencies in L1 and L2 sub-bands	15
Table 3.2 Geodetic constants and parameters of PZ-90.02 common terrestrial ellipsoid	25
Table 4.1 Arrangement of GLONASS almanac within superframe	30
Table 4.2 Accuracy of transmitted of coordinates and velocity for GLONASS satellite	33
Table 4.3 Word P1	34
Table 4.4 Word FT	36
Table 4.5 Characteristics of words of immediate information (ephemeris parameters)	37
Table 4.6 Arrangement of immediate information within frame	39
Table 4.7 Word KP	42
Table 4.8 Relationship between "age" of almanac and accuracy of positioning	42
Table 4.9 Characteristics of words of non-immediate information (almanac)	43

Table 4.10 Negative numbers of GLONASS carriers within navigation message	45
Table 4.11 Arrangement of non-immediate information within frame	45
Table 4.12 Arrangement of reserved bits within super frame	46
Table 4.13 Algorithm for verification of data within string	48
Table 5.1 Health flags and operability of the satellite	51

ABBREVIATIONS

BIH	Bureau International de l'Heure
CCIR	Consultative Committee for International Radio
CS	Central Synchronizer
FDMA	Frequency division multiple access
GMT	Greenwich Mean Time
ICD	Interface Control Document
KNITs	Coordination Scientific Information Center
KX	Hamming Code
LSB	Least Significant Bit
MT	Moscow Time
MSB	Most Significant Bit
msd	mean-solar day
NPO PM	Scientific and Production Association of Applied Mechanics
PR	Pseudo random
RF	Radio frequency
RMS (σ)	Root mean square
ROM	Read only memory
RNII KP	Research Institute of Space Device Engineering
UTC	Coordinated Universal Time

1. INTRODUCTION

1.1 *GLONASS purpose*

The purpose of the Global Navigation Satellite System GLONASS is to provide unlimited number of air, marine, and any other type of users with all-weather three-dimensional positioning, velocity measuring and timing anywhere in the world or near-earth space.

1.2 *GLONASS components*

GLONASS includes three components:

- Constellation of satellites (space segment);
- Ground-based control facilities (control segment);
- User equipment (user segment).

Completely deployed GLONASS constellation is composed of 24 satellites in three orbital planes whose ascending nodes are 120 apart. 8 satellites are equally spaced in each plane with argument of latitude displacement 45. The orbital planes have 15 -argument of latitude displacement relative to each other. The satellites operate in circular 19100-km orbits at an inclination 64.8, and each satellite completes the orbit in approximately 11 hours 15 minutes. The spacing of the satellites allows providing continuous and global coverage of the terrestrial surface and the near-earth space.

The control segment includes the System Control Center and the network of the Command and Tracking Stations that are located throughout the territory of Russia. The control segment provides monitoring of GLONASS constellation status, correction to the orbital parameters and navigation data uploading.

User equipment consists of receives and processors receiving and processing the GLONASS navigation signals, and allows user to calculate the coordinates, velocity and time.

1.3 Navigation determination concept

User equipment performs passive measurements of pseudoranges and pseudorange rate of four (three) GLONASS satellites as well as receives and processes navigation messages contained within navigation signals of the satellites. The navigation message describes position of the satellites both in space and in time. Combined processing of the measurements and the navigation messages of the four (three) GLONASS satellites allows user to determine three (two) position coordinates, three (two) velocity vector constituents, and to refer user time scale to the National Reference of Coordinated Universal Time UTC(SU).

The data ensuring of sessions scheduling for navigational determinations, selection of working "constellation" of SVs and detection of radiosignals transmitted by them, are transmitted as a part of the navigation message.

2. GENERAL

The section 2 contains the definition of the Interface Control Document (ICD), procedure of approval and revision of ICD, and the list of organizations approving this document and authorized to insert additions and amendments to agreed version of ICD.

2.1 ICD definition

The GLONASS Interface Control Document specifies parameters of interface between

GLONASS space segment and user equipment in L1 and L2 Bands

2.2 ICD approval and revision

The «Russian Institute of Space Device Engineering» (RIS DE) is a developer of the GLONASS satellite onboard equipment, being considered as a developer of control interface, is responsible for development, coordination, revision and maintenance of ICD.

To enter into effect, ICD should be signed by the following organizations:

Scientific and Production Association of Applied Mechanics (SPAAM) of Russian Space Agency of developer of GLONASS system as a whole including the satellites and software for control segment;

(RIS DE) of Russian Space Agency as developer of GLONASS system including control segment, satellite onboard equipment and user equipment;

Coordination Scientific Information Center (KNITs) (Ministry of Defense), and approved by duly authorized representatives of Ministry of Defense and Russian Space Agency.

Federal state unitary firm « Research Institute of Space Device Engineering » («RIS DE») Roskosmos (Federal space agency) – directing agency on GLONASS system, the development engineer of an actual load and the auxiliary wirelesses and telemeter systems NKA, the complex of a terrestrial facilities of the control and control, a navigation set of user equipment for different users.

Open joint-stock company «Informational satellite systems» of a name of the academician M. F. Reshetnev (Open Society "ISS") Roskosmos – the development

engineer of the space complex of system GLONASS, including the space-rocket complex, the land control complex and software.

4 Central scientific research institutes of the Russian Federation Defense Ministry – a head research establishment of the Russian Ministry of Defense on GLONASS system.

ICD Affirms with plenipotentiaries of the Space troops and Roskosmos.

In the course of deployment and the GLONASS system development its separate parameters can vary. Modifications agreed before edition ICD can be offered any of the responsible sides and, in turn, also should be agreed and approved by the all responsible sides. The development engineer of the monitoring interface bears responsibility for negotiation of the offered modifications with all responsible sides and for preparation, if necessary, the new edition of the Document containing modifications.

In present ICD edition considered series of notes and users proposals on the previous edition of the Document, and also a number of parameters are inducted in the interface between PKA and user equipment.

Official distribution of the GLONASS ICD v.5.1 executes the Russian Institute of Space Device Engineering.

3. REQUIREMENTS

This section specifies general characteristics of GLONASS navigation signal, requirements to its quality, and provides brief description of its structure.

3.1 Interface definition

The interface between GLONASS space segment and users equipment NAP (ASN) consists of L-frequency range radio links (fig. 3.1).

Each GLONASS system SVs "Glonass" and "Glonass-M" transmits navigational radiosignals on fundamental frequencies in two frequency sub-bands (L1 ~ 1,6 GHz, L2 ~ 1,25 GHz). SVs, being in opposite points of an orbit plane (antipodal NKA), can transmit navigation radiosignals on equal frequencies.

SVs "Glonass" in sub-band L1 ray navigational signals of 2 types: a signal of a standard accuracy (ST), accessible to any users and a signal of pinpoint accuracy (W), accessible only to special users and in sub-band L2 only one signal of VT.

SVs "Glonass M" in sub-bands L1 and L2 ray navigational signals of 2 types: ST and VT.

The VT signal is modulated by a special code and intended for usage in interests of the

Usage of a VT signal should be agreed to the Russian Federation Defense Ministry.

In the present Document are considered structure and performances of navigation radio signal ST in sub-bands L1 and L2, transmitted by "Glonass" and "Glonass M" SVs.

3.2 Navigation signal structure

Navigation signal being transmitted in particular carrier frequency of L1 and L2 sub-bands is a multi-component one using a bipolar phase-shift key (BPSK) modulated binary train. The phase shift keying of the carrier is performed at π radians with the maximum error $\pm 0,2$ radians.

The carrier of L1 sub-band and phases of bearing oscillations of sub-bands L1 and L2 is modulated by the Modulo-2 addition of the following binary signals: pseudo random (PR) ranging code, digital data of navigation message and auxiliary meander sequence.

All above-mentioned components are generated using a single onboard time/frequency oscillator (standard).

3.2.1 Ranging code

PR ranging code is a sequence of the maximum length of a shift register (M-sequence)

with a period 1 millisecond and bit rate 511 kilobits per second.

3.2.2 Digital data of navigation message

The navigation message includes immediate and non-immediate data.

The immediate data relate to the satellite, which transmits given navigation signal. The non-immediate data (GLONASS almanac) relate to all satellites within GLONASS constellation.

The digital data are transmitted at 50 bits per second.

The content and the characteristics of the navigation message are given in Section 4.

3.3 Interface description

3.3.1 Navigation RF signal characteristics

3.3.1.1 Frequency plan

The nominal values of L1 and L2 carrier frequencies are defined by the following expressions:

$$\begin{aligned} f_{K1} &= f_{01} + K\Delta f_1, \\ f_{K2} &= f_{02} + K\Delta f_2, \text{ where} \end{aligned}$$

K-is a frequency number (frequency channel) of the signals transmitted by GLONASS satellites in the L1 and L2 sub-bands correspondingly;

$$f_{01} = 1602 \text{ M}; \Delta f_1 = 562,5 \text{ kHz, for sub-band L1;}$$

$$f_{02} = 1246 \text{ M}; \Delta f_2 = 437,5 \text{ kHz, for sub-band L2.}$$

The nominal values of carrier frequencies f_{K1} and f_{K2} for channel numbers K are given in Table 3.1.

Channel number K for any particular GLONASS satellite is provided in almanac (non-immediate data of navigation message, see paragraph 4.5).

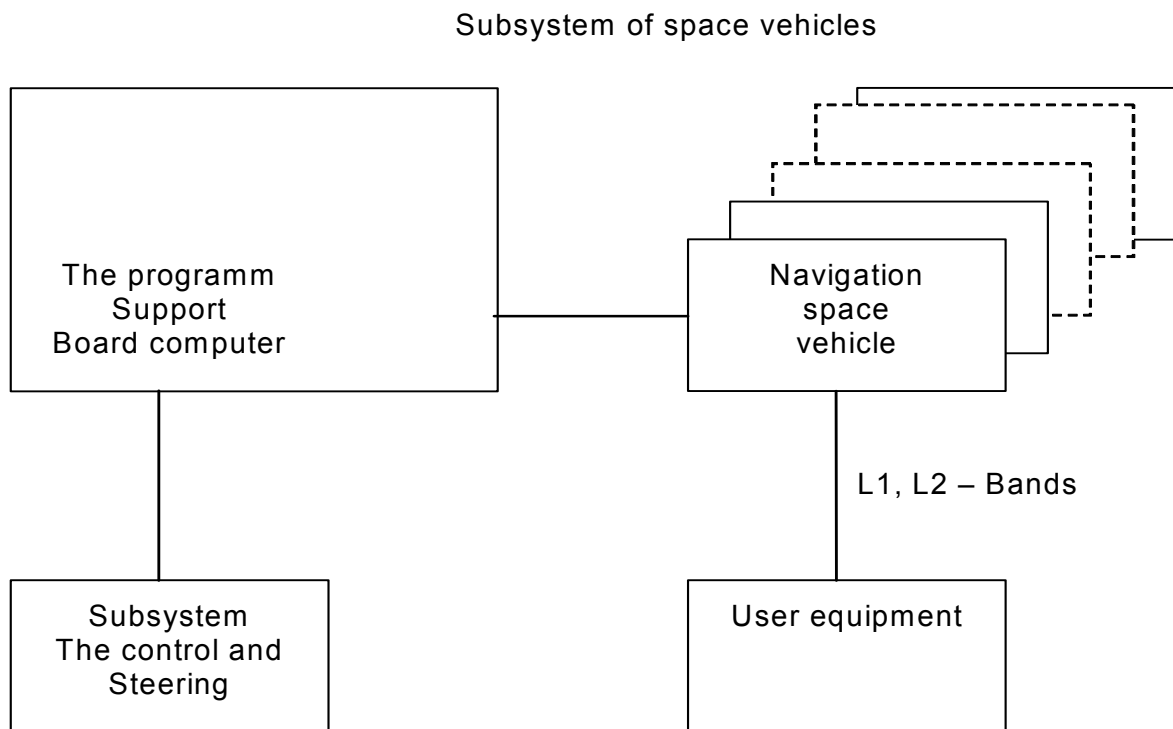

Fig. 3.1. SV Interface and User equipment

For each satellite, carrier frequencies of L1 and L2 sub-bands are coherently derived from a common onboard time/frequency standard. The nominal value of frequency, as observed on the ground, is equal to 5.0 MHz. To compensate relativistic effects, the nominal value of the frequency, as observed at satellite, is biased from 5.0 MHz by relative value $f/f = -4.36 \cdot 10^{-10}$ or $f = -2.18 \cdot 10^{-3}$ Hz that is equal to 4.99999999782 MHz (the value is given for nominal orbital height 19100 km). Ratio of carrier frequencies of L1 and L2 sub-bands is equal to $f_{K2}/f_{K1} = 7/9$

The values of the carrier frequencies of the satellites are within 2×10^{-11} relative to its nominal value f_k .

Table 3.1 GLONASS carrier frequencies in L1 and L2 sub-bands

No. of channel	Nominal value of frequency in L1 sub-band, MHz	No. of channel	Nominal value of frequency in L2 sub-band, MHz
----------------	--	----------------	--

No. of channel	Nominal value of frequency in L1 sub-band, MHz	No. of channel	Nominal value of frequency in L2 sub-band, MHz
06	1605,375	06	1248,625
05	1604,8125	05	1248,1875
04	1604,25	04	1247,75
03	1603,6875	03	1247,3125
02	1603,125	02	1246,875
01	1602,5625	01	1246,4375
00	1602,0	00	1246,0
-01	1601,4375	-01	1245,5625
-02	1600,8750	-02	1245,1250
-03	1600,3125	-03	1244,6875
-04	1599,7500	-04	1244,2500
-05	1599,1875	-05	1243,8125
-06	1598,6250	-06	1243,3750
-07	1598,0625	-07	1242,9375

According to guidelines of the International Electric communication union (MSE) in system GLONASS the modification of frequency band for a signal of a standard accuracy from numbers of frequencies $K = 0$ is envisioned... +24 on numbers $K = (-7...+6)$. All GLONASS SVs launched after 2005 will use numbers of frequencies $K = (-7... +6)$.

3.3.1.2 Correlation loss

Correlation loss are stipulated by non sublime modulator and limitation of a radio signal spectrum in the transmitter of NS. For a navigational signal of a standard accuracy correlation losses are negligibility small.

3.3.1.3 Carrier phase noise

The phase noise spectral density of the non-modulated carrier is such that a phase locked loop of 10 Hz one-sided noise bandwidth provides the accuracy of carrier phase tracking not worse than 0.1 radian (1).

3.3.1.4 Spurious emissions

Power of transmitted RF signal beyond of the following GLONASS allocated bandwidths

(1598.0625 1605.375) MHz 0.511 MHz,

(1242.9375 1248.625) MHz 0.511 MHz

(see paragraph 3.3.1.1) shall not be more than -40 dB relative to power of non-modulated carrier.

NKA "Glonass-M" is equipped with the filters diminishing unwanted emissions in frequency ranges:

(1610,6 ... 1613,8) MHz;

(1660,0 ... 1670,0) MHz,

To the level resulted in Guideline IDP-R RA.769.

3.3.1.5 Intrasystem interference

Intrasystem interference caused by the inter-correlation properties of PR ranging code and FDMA technique utilized in GLONASS. When receiving navigation signal on frequency channel $K = n$, an interference created by navigation signal with frequency $K = n-1$ or $K = n+1$ is not more than (-48 dB) provided that the satellites transmitting signals on adjacent frequencies are simultaneously visible for an user.

3.3.1.6 Received power level

The power level of the received RF signal from GLONASS satellite at the output of a 3dBi linearly polarized antenna is not less than -161 dBW for L1 sub-band provided that the satellite is observed at an angle of 5 or more. The power level of the received RF signal from GLONASS-M satellite at the output of a 3dBi linearly polarized antenna is not less than -161 dBW for L1 sub-band and not less than -167 dBW (with the subsequent increasing to a level not less than -161 dBW) for L2 sub band provided that the satellite is observed at an elevation angle of 5 or more. Further information on received power level is given in Appendix 1.

3.3.1.7 Equipment group delay

Equipment group delay is defined as a delay between transmitted RF signal (measured at phase center of transmitting antenna) and a signal at the output of onboard time/frequency standard.

The delay consists of determined and undetermined components. The determined component is no concern to an user since it has no effect on the GLONASS time computations. The undetermined component does not exceed 8 nanoseconds for GLONASS satellite and 2 nanoseconds for GLONASS-M satellite.

3.3.1.8 Signal coherence

All components of transmitted RF signal are coherently derived from carrier frequency of only one onboard time/frequency standard.

3.3.1.9 Polarization

Navigation RF signal transmitted in L1 and L2 sub-bands by each GLONASS satellite is right-hand circularly polarized. The elliptic coefficient of the field is not worse than 0.7 (for both L1 and L2 sub-bands) for the angular range 19 from bore sight.

Not worse 0,7 in L1 sub-band;

Not worse 0,7 in L2 sub-band.

3.3.2 Modulation

The modulating sequence used for modulation of carrier frequencies sub-bands (when generating standard accuracy signals) in L1 for GLONASS satellites and L1, L2 for GLONASS-M satellites is generated by the Modulo-2 addition of the following three binary signals:

- PR ranging code transmitted at 511 kbps;
- navigation message transmitted at 50 bps, and 100 Hz auxiliary meander sequence.

Given sequences are used for modulation of carriers in L1 and L2 sub-bands when generating standard accuracy signals.

3.3.2.1 Ranging code generation

PR ranging code is a sequence of maximum length of shift register with a period 1 millisecond and bit rate 511 kbps. PR ranging code is sampled at the output of 7th stage of the 9-stage shift register. The initialization vector to generate this sequence is (11111111). The first character of the PR ranging code is the first character in the group 111111100, and it is repeated every 1 millisecond. The generating polynomial, which corresponds to the 9-stage shift register (see Fig. 3.2), is

$$G(X) = 1 + X_5 + X_9$$

Simplified block-diagram of the PR ranging code and clock pulse generation is given in Fig. 3.3.

3.3.2.2 Navigation message generation

The navigation message is generated as a pattern of continuously repeating strings with duration 2 seconds. During the first 1.7 seconds within this two-second interval (in the beginning of each string) 85 bits of navigation data are transmitted. During the last 0.3 second within this two second interval (in the end of each string) the time mark is transmitted. Binary train of the navigation message is Modulo-2 addition of the following binary components:

- a sequence of bits of the navigation message digital data in relative code and with duration of one bit 20 milliseconds;
- a meander sequence with duration of one bit 10 millisecond.

The binary code of the time mark is a shortened pseudo random sequence of 30 bits, and duration of one bit is equal to 10 milliseconds. This sequence is described by the following generating polynomial:

$$g(x) = 1 + x_3 + x_5,$$

or may be shown as 111110001101110101000010010110.

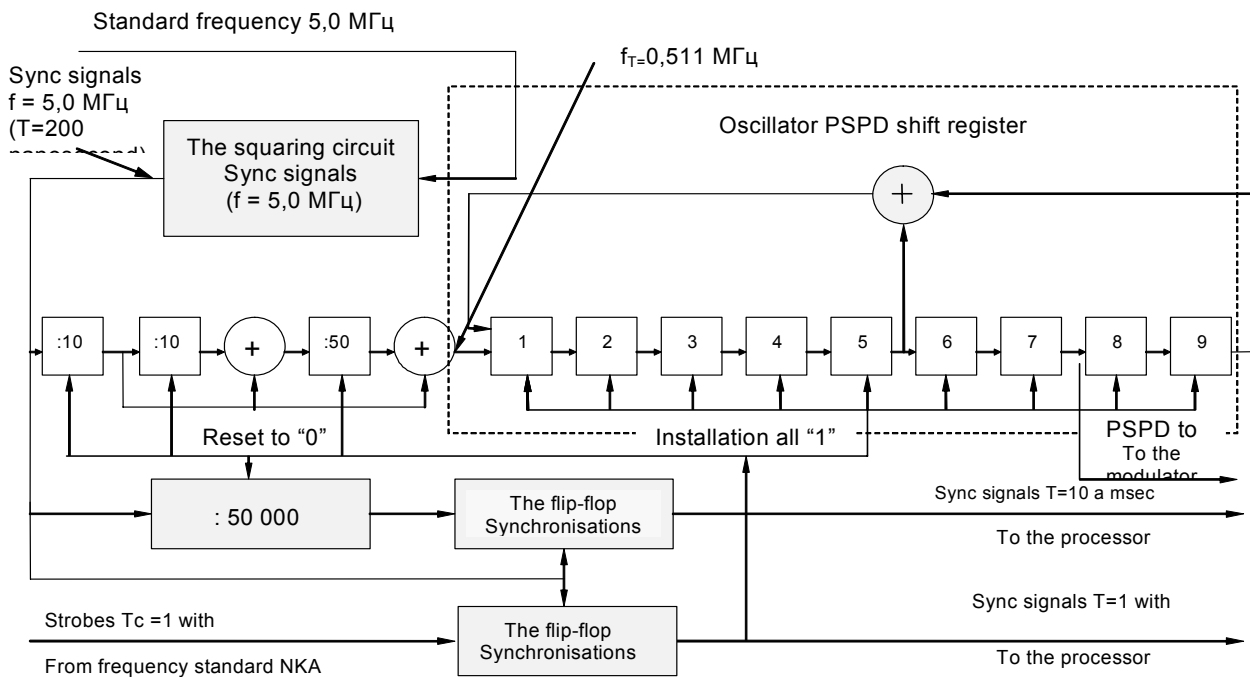

Figure 3.3 Simplified diagram of PR ranging code and clock pulse generation

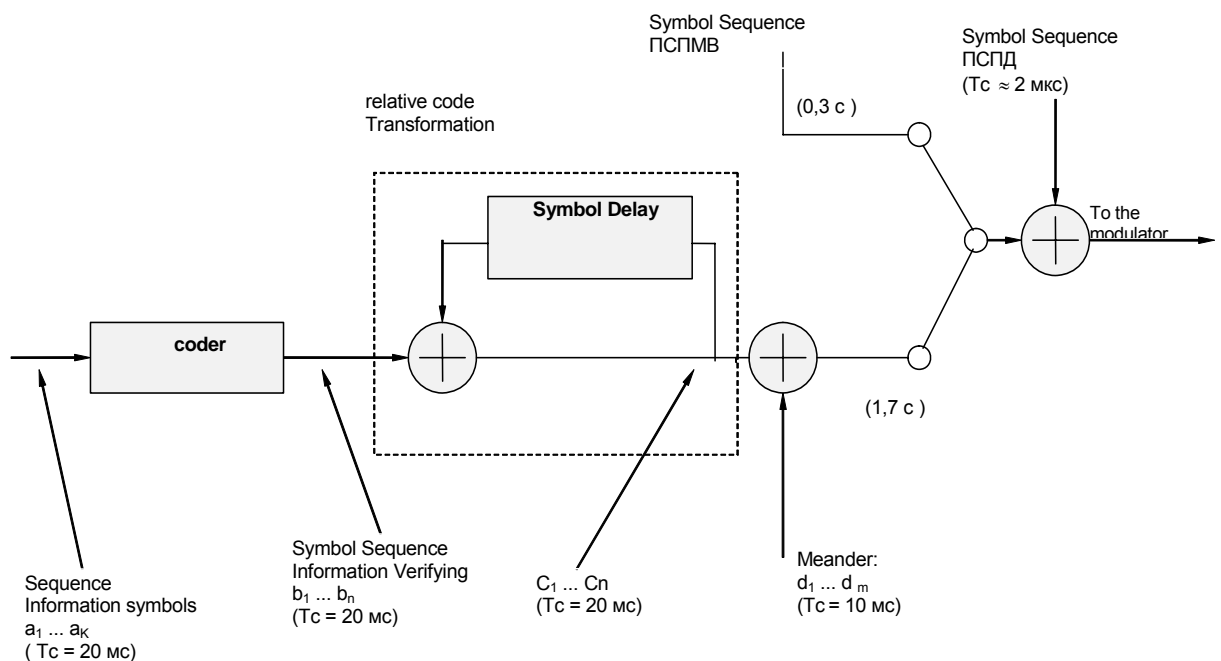

Figure 3.4 Simplified block-diagram of data sequence generation

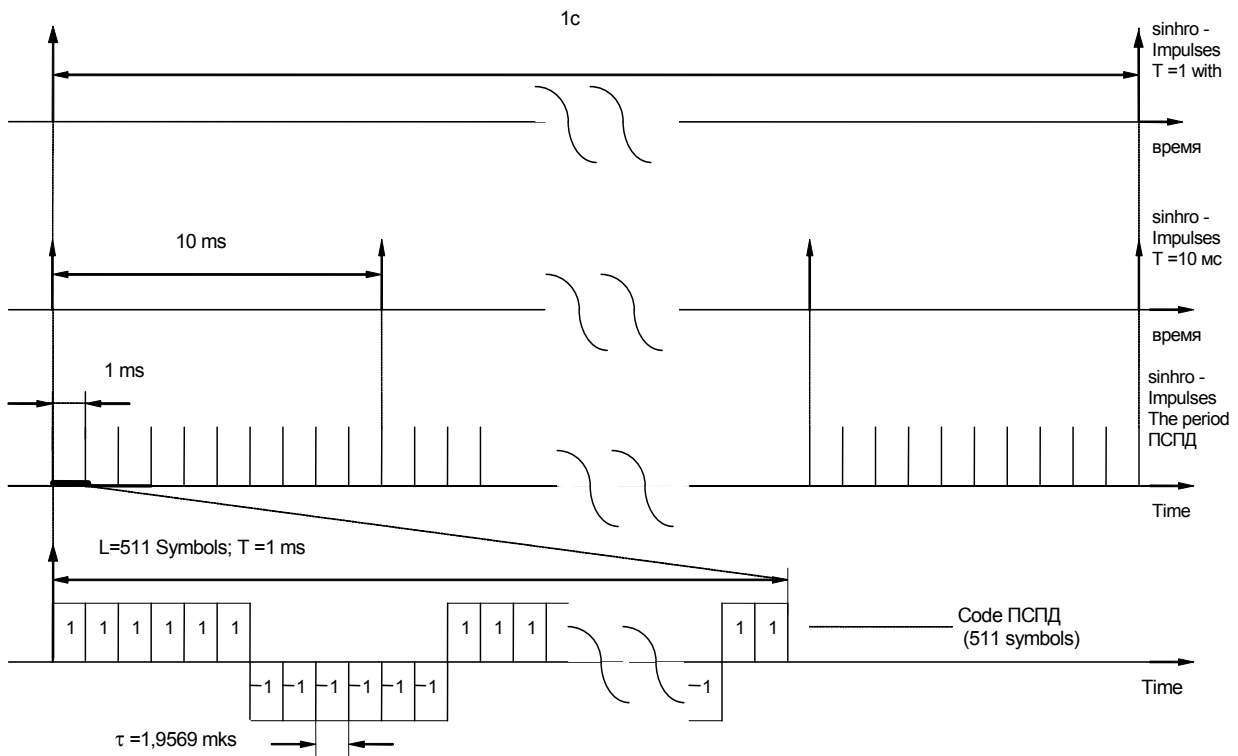

Figure 3.5 Time relationship between clock pulses and PR ranging code

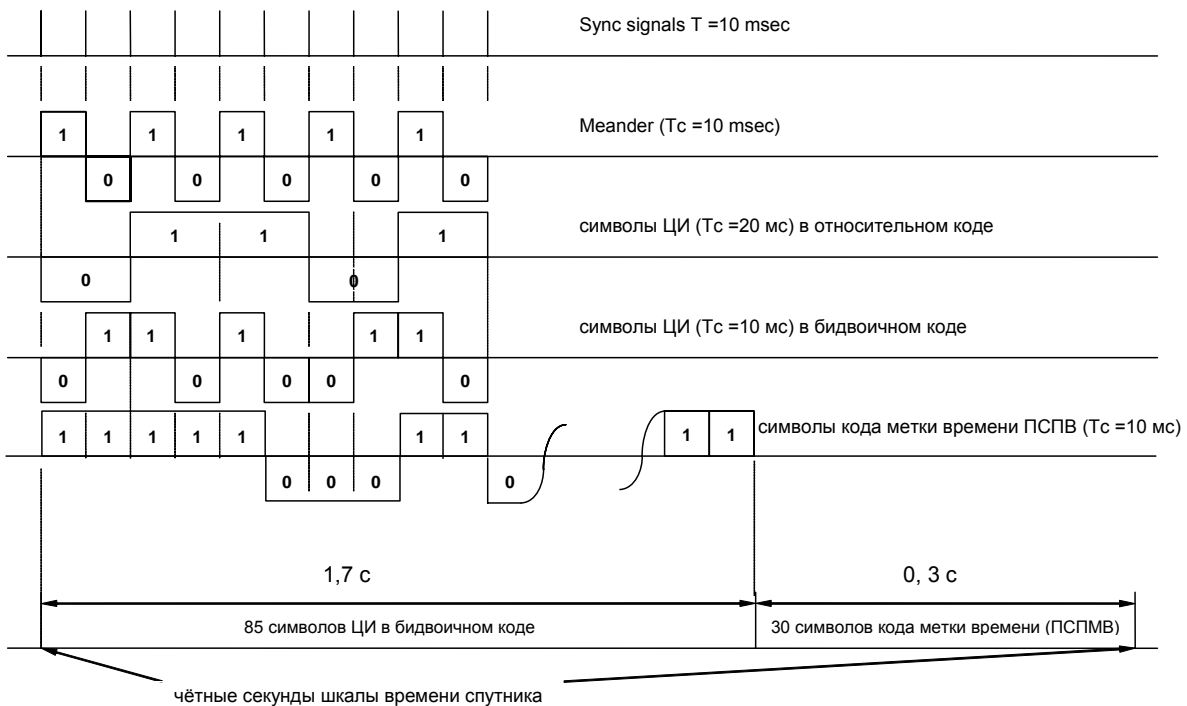

Figure 3.6 Data sequence generation in onboard processor

3.3.3 GLONASS time

The GLONASS satellites are equipped with clocks (time/frequency standards) which daily instability is not worse than $5 \cdot 10^{-13}$ and $1 \cdot 10^{-13}$ for the GLONASS-M satellites. An accuracy of mutual synchronization of the satellite time scales is not worse than 20 nanoseconds (1) for the GLONASS and to 8 nanoseconds (1) for the GLONASS-M satellites.

GLONASS time is generated on a base of GLONASS Central Synchronizer (CS) time. Daily instability of the Central Synchronizer hydrogen clocks is not worse than 2×10^{-15}

The time scales of the GLONASS satellites are periodically compared with the CS time scale. Corrections to each onboard time scale relative to GLONASS time and UTC (SU) (see Section 4), re computed and uploaded to the satellites twice a day by control segment. The error of a scale system binding of the GLONASS UTC (SU) time scale should not exceed 1 mks.

The GLONASS time scale is periodically corrected to integer number of seconds simultaneously with UTC corrections that are performed according to the Bureau International de l Heure (BIH) notification (leap second correction). Typically, these corrections (1s) are performed once a year (or 1.5 years) at midnight 00 hours 00 minutes 00 seconds UTC from December 31 to January 1 1-st quarter (or from March 31 to April 1 2-nd quarter or from June 30 to July 1 3-rd quarter or from September 30 to October 1- 4-th quarter) by all UTC users.

The GLONASS users are notified in advance (at least three months before) on these planned corrections through relevant bulletins, notifications etc. The GLONASS satellites have not any data concerning the UTC leap second correction within their navigation messages.

Navigation message of GLONASS-M satellites stipulates provision of advance notice for users on forthcoming UTC leap second correction, its value and sign (see Section 4.5, word KP within almanac).

Typically, these corrections (1s) are performed once a year (or 1.5 years) at midnight 00 hours 00 minutes 00 seconds UTC from December 31 to January 1 1-st quarter (or from March 31 to April 1 2-nd quarter or from June 30 to July 1 3-rd quarter or from September 30 to October 1- 4-th quarter) by all UTC users. General recommendations concerning operation of GLONASS receiver upon the UTC leap second correction are given in Appendix 2. Due to the leap second correction there is no integer-second difference between GLONASS time and UTC (SU). However, there is constant three-hour difference between these time scales due to GLONASS control segment specific features:

$$T_{ГЛ} = T_{UTC(SU)} + 03 \text{ hour } 00 \text{ mines}$$

To re-compute satellite ephemeris at a moment of measurements in UTC(SU) the following equation shall be used:

$$T_{\text{UTC(SU)}} + 03 \text{ hour } 00 \text{ mins} = t + \tau_c + \tau_n(t_b) - \gamma_n(t_b)(t - t_b),$$

time of transmission of navigation signal in onboard time scale (parameters c , n , n , and t_b are given in Sections 4.4 and 4.5).

GLONASS-M satellite transmitted coefficients B1 and B2 to determine the difference between Universal Time UT1 and Universal Coordinated Time UTC.

GLONASS-M satellite transmitted $_{\text{GPS}}$ - correction to GPS time relative to GLONASS time (or difference between these time scales) which shall be not more 30 ns ().

3.3.4 Coordinate system

The GLONASS broadcast ephemeris describes a position of transmitting antenna phase center of given satellite in the PZ-90.02 Earth-Centered Earth-Fixed reference frame defined as follows:

The ORIGIN is located at the center of the Earth's body;

The Z-axis is directed to the Conventional Terrestrial Pole as recommended by the International Earth Rotation Service (IERS);

The X-axis is directed to the point of intersection of the Earth's equatorial plane and the zero meridian established by BIH;

The Y-axis completes the coordinate system to the right-handed one.

Geodetic coordinates of a point in the PZ-90.02 coordinate system refers to the ellipsoid which semi-major axis and flattening are given in Table 3.2

Geodetic latitude B of a point M is defined as angle between the normal to the ellipsoid surface and equatorial plane.

Geodetic longitude L of a M point is determined as a corner between a plane of a prime meridian and a meridian plane, M. Transiting through a point a direction of the score of longitudes - from a prime meridian to the east from 0 to 360 grades.

Geodetic height H of a point M is defined as a distance from the ellipsoid surface to the point M along the normal.

Fundamental geodetic constants and other significant parameters of the common terrestrial ellipsoid PZ-90.02 are given in Table 3.2.

Table 3.2 Geodesic constants and parameters uniearth ellipsoid ПЗ 90.02

Earth rotation rate	$7,292115 \times 10^{-5}$ rad/s
Gravitational constant	$398\,600,4418 \times 10^9$ m ³ /s ²
Gravitational constant of atmosphere (fM_a)	0.35×10^9 m ³ /s ²
Speed of light	299 792 458 m/s
Semi-major axis	6 378 136 m
Flattening	1/298,257 84
Equatorial acceleration of gravity	978 032,84 mGal
Correction to acceleration of gravity at sea-level due to Atmosphere	0,87 mGal
Second zonal harmonic of the geopotential (J_2^0)	$1082625,75 \times 10^{-9}$
Fourth zonal harmonic of the geopotential (J_4^0)	$(- 2370,89 \times 10^{-9})$
Sixth zonal harmonic of the geopotential (J_6^0)	$6,08 \times 10^{-9}$
Eighth zonal harmonic of the geopotential (J_8^0)	$1,40 \times 10^{-11}$
Normal potential at surface of common terrestrial ellipsoid (U_0)	$62\,636\,861,4$ m ² /s ²

Note. To calculate of orbit parameters same times can be used next normalized harmonic of the normal geopotential (PZ-90.02):

$$\bar{C}_{20}^0 = -484165,0 \times 10^{-9}; \quad \bar{C}_{40}^0 = 790,3 \times 10^{-9}$$

Conection between this paramters and ICD paramters are:

$$J_2^0 = - (5)^{1/2} \bar{C}_{20}^0; \quad (J_4^0)^- = - 3 \bar{C}_{40}^0$$

$$J_6^0 = - (11)^{1/2} \bar{C}_{60}^0; \quad J_8^0 = - (7)^{1/2} \bar{C}_{80}^0$$

Conection between paramters normal and unnormal geopotential are:

$$\Delta \bar{C}_{20} = \bar{C}_{20} - \bar{C}_{20}^0 \quad \Delta \bar{C}_{40} = \bar{C}_{40} - \bar{C}_{40}^0$$

4. NAVIGATION MESSAGE

A content and a format of the GLONASS and GLONASS-M satellites navigation message are given in this Section.

4.1 Navigation message purpose

The navigation message transmitted by the GLONASS and GLONASS-M satellites within navigation signal is purposed to provide users with requisite data for positioning, timing and planning observations.

4.2 Navigation message content

The navigation message includes immediate data and non-immediate data.

The immediate data relate to the GLONASS satellite which broadcasts given RFnavigation signal and include:

- enumeration of the satellite time marks;
- difference between onboard time scale of the satellite and GLONASS time;
- relative difference between carrier frequency of the satellite and its nominal value;
- ephemeris parameters and the other parameters (see section 4.4).

The non-immediate data contain almanac of the system including:

- data on status of all satellites within space segment (status almanac);
- coarse corrections to onboard time scale of each satellite relative to GLONASS time (phase almanac);
- orbital parameters of all satellites within space segment (orbit almanac);
- correction to GLONASS time relative to UTC(SU) and the other parameters (see section 4.5).

4.3 Navigation message structure

The navigation message is transmitted as a pattern of digital data that are coded by Hamming code and transformed into relative code. Structurally the data pattern is generated as continuously repeating super frames. A Superframe consists of the frames, and a frame consists of the strings.

The boundaries of strings, frames and Superframe of navigation messages from different GLONASS satellites are synchronized within 2 milliseconds.

4.3.1 Superframe structure

The superframe has duration 2.5 minutes and consists of 5 frames. Each frame has duration 30 seconds and consists of 15 strings. Each string has duration 2 seconds. Within each frame a total content of non-immediate data (almanac for 24 GLONASS system satellites) are transmitted. Superframe structure with indication of frame numbers in the superframe and string numbers in the frames is given in Fig. 4.1.

Figure4.1 Superframe structure

4.3.2 Frame structure

The superframe has duration 2.5 minutes and consists of 5 frames. Each frame has duration 30 seconds and consists of 15 strings. Each string has duration 2 seconds. Within each frame the total content of immediate data for given satellite and a part of no immediate data are transmitted. Frame structure within superframe is given in Fig. 4.2. The frames 1-4 are identical. Shaded area in Fig. 4.2 indicates reserved bits are to be utilized in future modernization of the navigation message structure.

The data contained in strings 1-4 of each frame relate to the satellite that transmits given navigation message (immediate data). The immediate data are the same within one superframe. The strings 6-15 of each frame contain non-immediate data (almanac) for 24 satellites. The frames 1-4 contain almanac for 20 satellites (5 satellites per frame). The 5th frame contains remainder of almanac for 4 satellites. Non-immediate data (almanac) for one satellite occupy two strings. Data contained in 5th string of each frame are the same within one superframe and relate to non-immediate data. Arrangement of almanac within superframe is given in Table 4.1.

Table 4.1 Arrangement of GLONASS almanac within superframe

Frame number within superframe	Satellite numbers, for which almanac is transmitted within given superframe
1	1 – 5
2	6 – 10
3	11 – 15
4	16 – 20
5	21 - 24

№ Строки (P2 ¹)	1	m ⁴	2	P1	2	t _k	12	x _n '(t _b)	24	x _n ''(t _b)	5	x _n (t _b)	27	KX	8	MB									
	2	m ⁴	3	B _n	3	t _b	7	y _n '(t _b)	24	y _n ''(t _b)	5	y _n (t _b)	27	KX	8	MB									
	3	m ⁴	1	γ _n (t _b)	11	1	p	1	z _n '(t _b)	24	z _n ''(t _b)	5	z _n (t _b)	27	KX	8	MB								
(C _n)	4	m ⁴	τ _n (t _b)				22	Δτ _n	5	E _n	5	P4 ¹⁴ 11		F _T	4	3	N _T	11	n	5	M	2	KX	8	MB
	5	m ⁴	N ^A				11	τ _c				32	1	N ₄	5	τ _{GPS}				22	I _n	KX	8	MB	
	6	m ⁴	2	M _n ²	n ^A	5	τ ^A _n	10	λ ^A _n	21	Δi ^A _n	18	ε ^A _n				15	KX	8	MB					
	7	m ⁴	ω ^A _n				16	t ^A _{λⁿ}	21	ΔT ^A _n	22	ΔT ^A _n ⁷	H ^A _n	5	I _n	KX	8	MB							
	8	m ⁴	2	M _n ²	n ^A	5	τ ^A _n	10	λ ^A _n	21	Δi ^A _n	18	ε ^A _n				15	KX	8	MB					
	9	m	ω ^A _n				16	t ^A _{λⁿ}	21	ΔT ^A _n	22	ΔT ^A _n ⁷	H ^A _n	5	I _n	KX	8	MB							
	10	m ⁴	2	M _n ²	n ^A	5	τ ^A _n	10	λ ^A _n	21	Δi ^A _n	18	ε ^A _n				15	KX	8	MB					
	11	m ⁴	ω ^A _n				16	t ^A _{λⁿ}	21	ΔT ^A _n	22	ΔT ^A _n ⁷	H ^A _n	5	I _n	KX	8	MB							
	12	m ⁴	2	M _n ²	n ^A	5	τ ^A _n	10	λ ^A _n	21	Δi ^A _n	18	ε ^A _n				15	KX	8	MB					
	13	m ⁴	ω ^A _n				16	t ^A _{λⁿ}	21	ΔT ^A _n	22	ΔT ^A _n ⁷	H ^A _n	5	I _n	KX	8	MB							
	14	m ⁴	2	M _n ²	n ^A	5	τ ^A _n	10	λ ^A _n	21	Δi ^A _n	18	ε ^A _n				15	KX	8	MB					
	15	m ⁴	ω ^A _n				16	t ^A _{λⁿ}	21	ΔT ^A _n	22	ΔT ^A _n ⁷	H ^A _n	5	I _n	KX	8	MB							

Figure 4.2a Frame structure, 1st 4th frames

№ Строки (P2 ¹)	1	m ⁴	2	P1	2	t _k	12	x _n '(t _b)	24	x _n ''(t _b)	5	x _n (t _b)	27	KX	8	MB									
	2	m ⁴	3	B _n	3	t _b	7	y _n '(t _b)	24	y _n ''(t _b)	5	y _n (t _b)	27	KX	8	MB									
	3	m ⁴	1	γ _n (t _b)	11	1	p	1	z _n '(t _b)	24	z _n ''(t _b)	5	z _n (t _b)	27	KX	8	MB								
(C _n)	4	m ⁴	τ _n (t _b)				22	Δτ _n	5	E _n	5	P4 ¹⁴ 11		F _T	4	3	N _T	11	n	5	M	2	KX	8	MB
	5	m ⁴	N ^A				11	τ _c				32	1	N ₄	5	τ _{GPS}				22	I _n	KX	8	MB	
	6	m ⁴	2	M _n ²	n ^A	5	τ ^A _n	10	λ ^A _n	21	Δi ^A _n	18	ε ^A _n				15	KX	8	MB					
	7	m ⁴	ω ^A _n				16	t ^A _{λⁿ}	21	ΔT ^A _n	22	ΔT ^A _n ⁷	H ^A _n	5	I _n	KX	8	MB							
	8	m ⁴	2	M _n ²	n ^A	5	τ ^A _n	10	λ ^A _n	21	Δi ^A _n	18	ε ^A _n				15	KX	8	MB					
	9	m	ω ^A _n				16	t ^A _{λⁿ}	21	ΔT ^A _n	22	ΔT ^A _n ⁷	H ^A _n	5	I _n	KX	8	MB							
	10	m ⁴	2	M _n ²	n ^A	5	τ ^A _n	10	λ ^A _n	21	Δi ^A _n	18	ε ^A _n				15	KX	8	MB					
	11	m ⁴	ω ^A _n				16	t ^A _{λⁿ}	21	ΔT ^A _n	22	ΔT ^A _n ⁷	H ^A _n	5	I _n	KX	8	MB							
	12	m ⁴	2	M _n ²	n ^A	5	τ ^A _n	10	λ ^A _n	21	Δi ^A _n	18	ε ^A _n				15	KX	8	MB					
	13	m ⁴	ω ^A _n				16	t ^A _{λⁿ}	21	ΔT ^A _n	22	ΔT ^A _n ⁷	H ^A _n	5	I _n	KX	8	MB							
	14	m ⁴	B ₁		11	B ₂		10	KP ²								KX	8	MB						
	15	m ⁴												I _n	KX	8	MB								

Figure. 4.2b Frame structure, 5th frame

4.3.3 String structure

String is a structural element of the frame. String structure is given in Fig. 4.3. Each string contains data bits and time mark. String has duration 2 seconds, and during the last 0.3 seconds within this two-second interval (in the end of each string) the time mark is transmitted. The time mark (shortened pseudo random sequence) consists of 30 chips. Duration of the chip is 10 milliseconds (see paragraph 3.3.2.2). During the first 1.7 seconds within this two-second interval (in the beginning of each string) 85 bits of data are transmitted (the Modulo-2 addition of 50 Hz navigation data and 100 Hz auxiliary meander sequence (bi-binary code)).

The numbers of bits in the string are increased from right to the left. Along with data bits (bit positions 9-84) the check bits of Hamming code (KX) (bit positions 1-8) are transmitted.

The Hamming code has a code length of 4. The data of one string are separated from the data of adjacent strings by time mark (MB). The words of the data are registered by most significant bit (MSB) ahead. The last bit in each string (bit position 85) is idle chip ("0"). It serves for realization of sequential relative code when transmitting the navigation data via radio link.

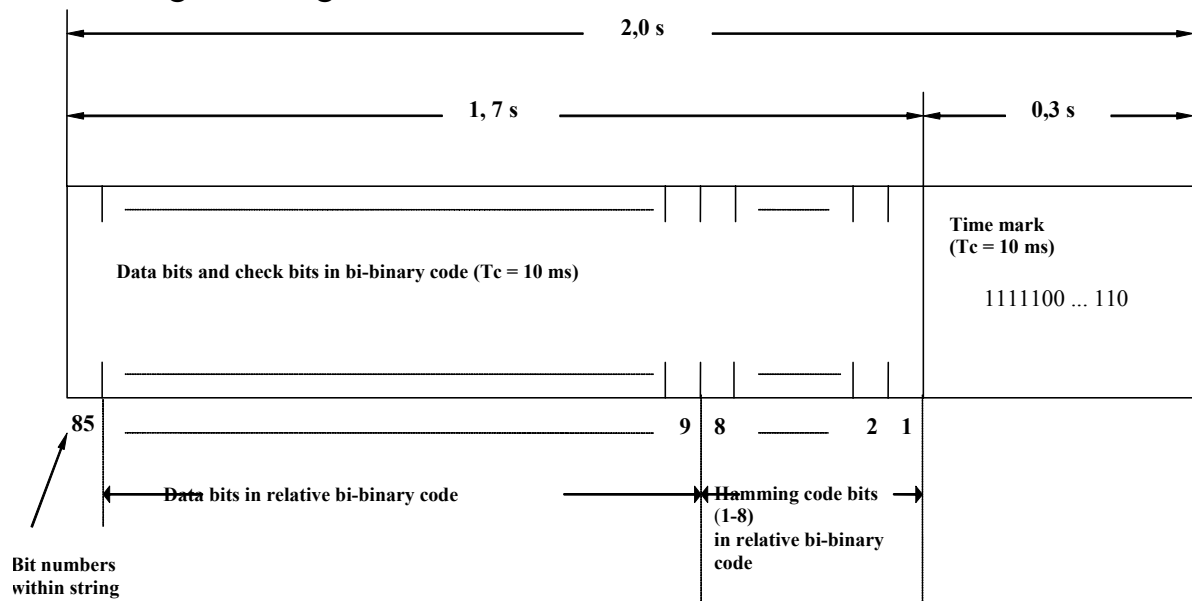

Figure 4.3 String structure

4.4 Immediate information and ephemeris parameters

Characteristics of words of immediate information (ephemeris parameters) are given in Table 4.5. In the words which numerical values may be positive or negative, the MSB is the sign bit. The chip "0" corresponds to the sign "+", and the chip "1" corresponds to the sign "-".

Ephemeris parameters are periodically computed and uploaded to the satellites by control segment. Mean square errors of transmitted coordinates and velocities of the satellites are given in Table 4.2.

Table 4.2 Accuracy of transmitted of coordinates and velocity for GLONASS satellite

Error component	Mean square error			
	predicted coordinates (m)		velocity (cm/s)	
SV	GLONASS	GLONASS-M	GLONASS	Glonass-M
Along track component	20	7	0,05	0,03
Cross track component	10	7	0,1	0,03
Radial component	5	1,5	0,3	0,2

The designations and explanations of the navigation message words are given below in table 4.5.

Frame structure within superframe is given in Fig. 4.2.

Word m is the string number within the frame;

Word t_k is the time referenced to the beginning of the frame within the current day. It is calculated according to the satellite time scale. The integer number of hours elapsed since the beginning of current day is registered in the five MSBs. The integer number of minutes elapsed since the beginning of the current hour is registered in the next six bits. The number of thirty-second intervals elapsed since the beginning of the current day is registered in the one LSB. The beginning of the day according to the satellite time scale coincides with the beginning of the recurrent superframe;

The beginning of the day according to the satellite time scale coincides with the beginning of the recurrent superframe;

Word B_n is the health flag. The user navigation equipment analyzes the only one MSB of this word, where 1 indicates the fact of malfunction of given satellite.

The user navigation equipment does not consider both second and third bits of this word.

Word t_b is an index of a time interval within current day according to UTC(SU) + 03 hours 00 min. The immediate data transmitted within the frame are referred to the middle of t_b - time interval. Duration of the time interval and therefore maximum value of the word t_b depend on value of a flag P1 (see below).

Word **P** is a technological parameter of control segment, indication the satellite operation mode in respect of time parameters ⁽¹⁾:

00 - c parameter relayed from control segment, $_{GPS}$ parameter relayed from control segment;

01 - c parameter relayed from control segment, $_{GPS}$ parameter calculated on-board the GLONASS-M satellite;

10 - c parameter calculated on-board the GLONASS-M satellite, $_{GPS}$ parameter relayed from control segment;

11 - c parameter calculated on-board the GLONASS-M satellite, $_{GPS}$ parameter calculated on-board the GLONASS-M satellite.

Word **P1** is flag of the immediate data updating. It indicates a time interval between two adjacent values of t_b parameter (in minutes) in both current and previous frames as indicated in Table 4.3;

Table 4.3 Word P1

Word P1	Time interval between adjacent values of t_b , minutes
00	0
01	30
10	45
11	60

Word **P2** is flag of oddness ("1") or evenness ("0") of the value of t_b (for intervals 30 or 60 minutes);

Word **P3** is flag indicating a number of satellites for which almanac is transmitted within given frame: 1 corresponds to five satellites and 0 corresponds to four satellites;

Word **P4** is flag to show that ephemeris parameters are present. "1" indicates that updated ephemeris or frequency/time parameters have been uploaded by the control segment ⁽¹⁾.

Note: Updated ephemeris or frequency/time information are transmitted only at the end of the

current interval t_b

Word N_T is current date, calendar number of day within four-year interval starting from the 1-st of January in a leap year ⁽¹⁾. An example of N_T transformation into the common form of current data information (dd/mm/yy) is presented in Attachment A 3.1.3.

Word n is an index of the satellite transmitting given navigation signal. It corresponds to a slot number within GLONASS constellation ⁽¹⁾;

Word F_T is a parameter that provides the predicted satellite user range accuracy at time t_b . Coding is as indicated in Table 4.4 ⁽¹⁾;

Word n time difference between navigation RF signal transmitted in L2 sub-band and aviation RF signal transmitted in L1 sub-band by n_{th} satellite.

$$n = t_{l2} - t_{l1}, \text{ where } t_{l1}, t_{l2}$$

equipment delays in L1 and L2 sub-bands correspondingly, expressed in units of time;

Word M is type of satellite transmitting navigation signal. "00" refers to GLONASS satellite, "01" refers to a GLONASS-M satellite ⁽¹⁾;

Table 4.4 Word F_T

Value of word F_T	Accuracy of measurements , m
0	1
1	2
2	2,5
3	4
4	5
5	7
6	10
7	12
8	14
9	16
10	32
11	64
12	128
13	256
14	512
15	Not used

Word n (t_b) is relative deviation of predicted carrier frequency value of n -satellite from nominal value at the instant t_b :

$$\gamma_n(t_b) = \frac{f_n(t_b) - f_{Hn}}{f_{Hn}},$$

$f_n(t_b)$ is predicted carrier frequency value of n-satellite taking account of gravitational and relativistic effects at the instant t_b

f_{Hn} is nominal value of carrier frequency of n_{th} satellite;

Word $n(t_b)$ is correction to the n_{th} satellite time t_n relative to GLONASS time t_c , which is equal to phase shift of PR ranging code of navigation signal transmitted by n_{th} satellite relative to the system reference signal at instant t_b , and expressed in units of time:

$$\tau_n(t_b) = t_c(t_b) - t_n(t_b);$$

Word l_n is health flag for n_{th} satellite; $l_n = 0$ indicates the n-th satellite is healthy, $l_n = 1$ indicates malfunction of this n_{th} satellite.

Table 4.5 Characteristics of words of immediate information (ephemeris parameters)

Word*	No. of bits	Scale factor (LSB)	Effective range	Units
m	4	1	0...15	dimensionless
tk	5	1	0...23	hours
	6	1	0...59	minutes
	1	30	0;30	seconds
tb	7	15	15...1425	minutes
M(1)	2	1	0-3	dimensionless
$\gamma_n(t_b)(2)$	11	2-40	$\pm 2-30$	dimensionless
$\tau_n(t_b)(2)$	22	2-30	$\pm 2-9$	seconds
$x_n(t_b), y_n(t_b), z_n(t_b)(2)$	27	2-11	$\pm 2,7 \cdot 10^4$	kilometers
$x_n(t_b), y_n(t_b), z_n(t_b)(2)$	24	2-20	$\pm 4,3$	km/s
$x_n(t_b), y_n(t_b), z_n(t_b)(2)$	5	2-30	$\pm 6,2 \cdot 10^{-9}$	km/s ²

Bn	3	1	0...7	dimensionless
P(1)	2	1	00,01,10,11	dimensionless
NT (1)	11	1	0...1461	days
FT(1)	4	(Table 4.4)		
n(1)	5	1	0...31	dimensionless
$\Delta\tau_n$ (2)	5	2-30	$\pm 13,97 \cdot 10^{-9}$	seconds
En	5	1	0...31	days
P1	2	(Table 4.3)		
P2	1	1	0;1	dimensionless
P3	1	1	0;1	dimensionless
P4(1)	1	1	0;1	dimensionless
ln(1)	1	1	0;1	dimensionless

Remarks (1): - the Yielded words are transmitted in navigational message of "Glonass - M" SV.

Remarks (2): - In the words which numerical meanings can be positive and subzero, the high bit is signed. Thus "0 character matches to "+" sign, and "1 character - to the sign" –".

Seating of words of current information of the navigational message in a frame is presented in table 4.6.

Table 4.6 Seating of words of a current information of the navigating Messages in a frame

Word	Number of Bits	String number	Number of bit in a string
m	4	1...15	81 - 84
t_k	12	1	65 - 76
t_b	7	2	70 - 76
M	2	4	9 - 10
$\gamma_n(t_b)$	11	3	69 - 79
$\tau_n(t_b)$	22	4	59 - 80
$x_n(t_b)$	27	1	9 - 35
$y_n(t_b)$	27	2	9 - 35
$z_n(t_b)$	27	3	9 - 35
$\overset{\cdot}{x}_n(t_b)$	24	1	41 - 64
$\overset{\cdot}{y}_n(t_b)$	24	2	41 - 64
$\overset{\cdot}{z}_n(t_b)$	24	3	41 - 64
$\overset{\cdot\cdot}{x}_n(t_b)$	5	1	36 - 40
$\overset{\cdot\cdot}{y}_n(t_b)$	5	2	36 - 40
$\overset{\cdot\cdot}{z}_n(t_b)$	5	3	36 - 40
P	2	3	66 - 67
N_T	11	4	16 - 26
n	5	4	11 - 15
F_T	4	4	30 - 33
E_n	5	4	49 - 53
B_n	3	2	78 - 80
P1	2	1	77 - 78
P2	1	2	77
P3	1	3	80
P4	1	4	34
$\Delta\tau_n$	5	4	54 - 58
l_n	1	3,5,7,9,11,13,15	65(3 rd string), 9(5,7,9,11,13,15 strings)

Words $x_n(t_b)$, $y_n(t_b)$, $z_n(t_b)$ - Co-ordinates of n th SV in co-ordinate system PZ-90.02 on an instant t_b ;

Words $\dot{x}_n(t_b)$, $\dot{y}_n(t_b)$, $\dot{z}_n(t_b)$ - Components of vector velocity of n th SV in co-ordinate system PZ-90.02 on an instant t_b ;

Words $\ddot{x}_n(t_b)$, $\ddot{y}_n(t_b)$, $\ddot{z}_n(t_b)$ - Component speedups of n th SV in co-ordinate system PZ-90.02 on an instant t_b , the Moons stipulated by operation and the Sun;

Word E_n - Characterises "age" of a current information, that is the time slice which has transited from the moment of calculation (backfilling) of a current information to an instant t_b for n th SV. Word E_n is shaped on board SV.

4.5 Non-immediate information and almanac

Non-immediate information (almanac) includes:

- data on GLONASS time;
- data on onboard time scales of all GLONASS satellites;
- data on orbital elements and health status of all GLONASS satellites.

Characteristics of words of non-immediate information (almanac) are given in Table 4.9.

The designations and explanations of the almanac words are given below:

Word τ_c is GLONASS time scale correction to UTC(SU) time. The correction τ_c is given at the instant of beginning of the day N^A ;

Word N_4 is four-year interval number starting from 1996 ⁽¹⁾ ;

Word τ_{GPS} is correction to GPS time relative to GLONASS time.

$T_{GPS} - T_{GL} = \Delta T + \tau_{GPS}$, where

ΔT is integer part, and τ_{GPS} is fractional part of the difference between the system time scales expressed in seconds.

Note. The integer part ΔT is determined from GPS navigation message in user receiver ⁽¹⁾;

Word N^A is calendar day number within the four-year period beginning since the leap year. The correction τ_c and other almanac data (almanac of orbits and almanac of phases) relate to this day number;

Word n^A is conventional number of satellite within GLONASS space segment, which corresponds to number of slot occupied by this satellite;

Word H_n^A is carrier frequency number of navigation RF signal transmitted by n^A -satellite;

Word λ_n^A is longitude of the first (within the N^A -day) ascending node of n^A -satellite orbit in PZ-90.02 coordinate system;

Word $t_{\lambda n}^A$ is time of the first ascending node passage of n^A -satellite within N^A -day;

Word Δi_n^A is correction to the mean value of inclination of n^A -satellite at instant of $t_{\lambda n}^A$ (mean value of inclination is equal to 63°);

Word ΔT_n^A is correction to the mean value of Draconian period of the n^A -satellite at instant of $t_{\lambda n}^A$ (mean value of Draconian period T is equal to 43200 s);

Word $\dot{\Delta T}_n^A$ is rate of change of Draconian period of n^A -satellite;

Word ε_n^A is eccentricity of n^A -satellite at instant of $t_{\lambda n}^A$;

Word ω_n^A is argument of perigee of n^A -satellite at instant of $t_{\lambda n}^A$;

Word M_n^A is a type of satellite n^A ⁽¹⁾; coding "00" indicates a GLONASS satellite, coding "01" indicates a GLONASS-M satellite;

Word **B1** is coefficient to determine $\Delta UT1$, it is equal to difference between UT1 and UTC(SU) at the beginning of the day (N^A), expressed in second ⁽¹⁾;

Word **B2** is coefficient to determine $\Delta UT1$, it is equal to the daily change of difference $\Delta UT1$ (expressed in second for a mean sun day) ⁽¹⁾.

These coefficients are used to transform between UTC(SU) and UT1:

$$\Delta UT1 = UTC(SU) - UT1,$$

where:

UT1 – Universal Time referenced to the Mean Greenwich Meridian (taking account of Pole motion),

UTC(SU) – Coordinated Universal Time for Russian Federation State Standard,

$$\Delta UT1 = B1 + B2*(NT - N^A),$$

Word **KP** is notification on forthcoming leap second correction of UTC (± 1 s), as show in Table 4.7 ⁽¹⁾.

Table 4.7 Word KP

KP	Information on UTC leap second correction
00	No UTC correction at the end of current quarter
01	UTC correction by plus (+1 s) in the end of current quarter.
11	UTC correction by minus (-1 s) in the end of current quarter.

The word **KP** appears in the navigation message at least eight weeks before the correction. However, a decision on forthcoming leap second correction can be made earlier than eight weeks before. So in case the decision has been taken the one of above values of the word KP is transmitted in the beginning of current quarter (the first five weeks). Otherwise $KP = 10$ is transmitted.

Word τ_n^A is coarse value of n^A - satellite time correction to GLONASS time at instant $t_{\lambda n}^A$, which is equal to phase shift of PR ranging code of transmitted navigation signal relative to the nominal position expressed in units of time;

Word C_n^A is generalized “unhealthy flag” of n^A -satellite at instant of almanac upload (almanac of orbits and phases). When $C_n = 0$, this indicates non-operability of n -satellite.

When $C_n = 1$, this indicates operability of n -satellite.

An accuracy of almanac parameters allows user to determine coordinates and radial velocity with the mean square errors depending of "age" of the almanac as indicated in Table 4.8.

Table 4.8 Relationship between "age" of almanac and accuracy of positioning

"Age" of almanac	Mean square error of measurement	
	range (km)	Radial velocity (m/s)
1 day	0.83	0.33
10 days	2.0	0.7
20 days	3.3	4.2

Table 4.9 Characteristics of words of non-immediate information (almanac)

Word*	No.of bits	Scale factor(LSB)	Effective range	Units
τ_c (1)(2)(3)	28	2^{-27}	± 1	s
(4)	32	2^{-31}	± 1	s
τ_{GPS} (1)	22	2^{-30}	$\pm 1.9 \cdot 10^{-3}$	day
(2)				
N_4 (1)	5	1	1...31	4-year interval
N^A	11	1	1...1461	days
n^A	5	1	1...24	dimensionless
H_n^A (3)	5	1	0...31	dimensionless
λ_n^A (2)	21	2^{-20}	± 1	semi-circle
$t_{\lambda_n}^A$	21	2^{-5}	0...44100	s
Δi_n^A (2)	18	2^{-20}	± 0.067	semi-circle
ΔT_n^A (2)	22	2^{-9}	$\pm 3.6 \cdot 10^3$	s/orbital period
$\dot{\Delta T}_n^A$ (2)	7	2^{-14}	$\pm 2^{-8}$	s/orbital period ²
ϵ_n^A	15	2^{-20}	0...0.03	dimensionless
ω_n^A (2)	16	2^{-15}	± 1	semi-circle
M_n^A (1)	2	1	0 - 3	dimensionless
B1 (1)	11	2^{-10}	± 0.9	s
(2)				
B2 (1)	10	2^{-16}	$(-4,5...3,5) \cdot 10^{-3}$	s/msd
(2)				
KP (1)	2	1	0,1	dimensionless

Word*	No. of bits	Scale factor(LSB)	Effective range	Units
τ_n^A	10	2^{-18}	$\pm 1,9 \cdot 10^{-3}$	s
C_n^A	1	1	0...1	dimensionless

Note (1): - These words are planned to insert into navigation message of GLONASS-M satellite.

Note (2): - In the words that numerical values may be positive or negative, the MSB is the sign bit. The chip "0" corresponds to the sign "+", and the chip "1" corresponds to the sign "-".

Note (3): - Negative values of frequency channel numbers are designated within navigation message as indicated in Table 4.10

Note (4): - Scale factor (LSB) of the word τ_C is increased to 2^{-31} s (that is to 0.46 ns) by allocation of additional bits for τ_C in navigation message of GLONASS-M satellite (up to 32 bits). The word τ_C will be located in 5th, 20th, 35th, and 65th strings within superframe, and it will occupy 38th to 69th bits.

Table 4.10 Negative numbers of GLONASS carriers within navigation message

Frequency channel number	Value of word H_n^A
-01	31
-02	30
-03	29
-04	28
-05	27
-06	26
-07	25

Arrangement of almanac words within frame is given in Table 4.11.

Table 4.11 Arrangement of non-immediate information within frame

Word*	No. of bits	(1) String number within frame	Bit number within string
τ_c	32	5	38 – 69 (see Note 4 for Table 4.9)
$N_4^{(1)}$	5	5	32 – 36
τ_{GPS}	22	5	10 - 31

Word*	No. of bits	(1) String number within frame	Bit number within string
N^A	11	5	70 - 80
n^A	5	6, 8, 10, 12, 14	73 - 77
H_n^A	5	7, 9, 11, 13, 15	10 - 14
λ_n^A	21	6, 8, 10, 12, 14	42 - 62
$t_{\lambda_n}^A$	21	7, 9, 11, 13, 15	44 - 64
Δi_n^A	18	6, 8, 10, 12, 14	24 - 41
ΔT_n^A	22	7, 9, 11, 13, 15	22 - 43
$\dot{\Delta T}_n^A$	7	7, 9, 11, 13, 15	15 - 21
ε_n^A	15	6, 8, 10, 12, 14	9 - 23
ω_n^A	16	7, 9, 11, 13, 15	65 - 80
M_n^A	2	6,8,10,12,14	78-79
B1	11	74	70-80
B2	10	74	60-69
KP	2	74	58-59
τ_n^A	10	6, 8, 10, 12, 14	63 - 72
C_n^A	1	6, 8, 10, 12, 14	80

4.6 Reserved bits

There are reserved bits within superframe for insertion an additional information. Arrangement of reserved bits within superframe, with an indication of the string number (unique indexing of strings within superframe is used) and the bit number are given in Table 4.12.

Table 4.12 Arrangement of reserved bits within super frame

String numbers within superframe	Position of bits within string	Number of bits
1, 16, 31, 46, 61	79, 80	2
2, 17, 32, 47, 62	65 - 69	5
3, 18, 33, 48, 63	68	1
4, 19, 34, 49, 64	27,28,29, 35 - 48	17
5, 20, 35, 50, 65	37	1
74	9 - 57	49
75	10 - 80	71

Note: - Position of reserved bits is given taking into account Notes 1 and 4 to Tables 4.5 and 4.9.

4.7 Data verification algorithm

This algorithm allows correcting an error in one bit within the string and detecting an error in two or more bits within the string. Each string includes 85 data bits where 77 most significant bits are data chips ($b_{85}, b_{84}, \dots, b_{10}, b_9$), and 8 least significant bits are check bits ($\beta_8, \beta_7, \dots, \beta_2, \beta_1$).

To correct one bit error within the string the following checksums are generated: (C_1, C_2, \dots, C_7), and to detect two-bit error (or more-even-number-of-bits error) a checksum C_Σ is generated. The rules for generation of the checksums (C_1, \dots, C_7 and C_Σ) when verifying the data within the string are given in Table 4.13.

The following rules are specified for correcting single errors and detecting multiple errors:

a) a string is considered correct if all checksums (C_1, \dots, C_7 , and C_Σ) are equal to zero, or if only one of the checksums (C_1, \dots, C_7) is equal to zero but $C_\Sigma = 1$;

b) if two or more of the checksums (C_1, \dots, C_7) are equal to 1 and $C_\Sigma = 1$, then character $b_{i_{cor}}$ is corrected to the opposite character in the following bit position:

$$i_{cor} = C_7 C_6 C_5 C_4 C_3 C_2 C_1 + 8 - K, \text{ provided that } i_{cor} \leq 85, \text{ where}$$

$C_7 C_6 C_5 C_4 C_3 C_2 C_1$ – binary number generated from the checksums (C_1, \dots, C_7) where all binary numbers are written by LSB to the right);

K is ordinal number of most significant checksum not equal to zero;

If a formula for i_{cor} gives $i_{KOP} > 85$ then it indicates that there is odd number of multiple errors. In this case data are not corrected but erased;

c) if at least one of the checksums (C_1, \dots, C_7) is equal to 1 and $C_\Sigma = 0$, or if all checksums (C_1, \dots, C_7) are equal to zero but $C_\Sigma = 1$, then it indicates that there are multiple errors and data are to be erased. Table 4.13 Algorithm for verification of data within string (an example)

$\beta_1, \beta_2, \dots, \beta_8$ – check bits of Hamming code (1-8);

$b_{77}, b_{76}, \dots, b_2, b_1$ – data bits (9-85);

$C_1, C_2, \dots, C_7, C_\Sigma$ - checksums;

$$C_1 = \beta_1 \oplus [\sum_i b_i] \text{ mod } 2$$

$$i = 9, 10, 12, 13, 15, 17, 19, 20, 22, 24, 26, 28, 30, 32, 34, 35, 37, 39, 41, 43,$$

45, 47, 49, 51, 53, 55, 57, 59, 61, 63, 65, 66, 68, 70, 72, 74, 76, 78, 80, 82,
84.

$$C2 = \beta2 \oplus [\sum_j b_j] \text{mod } 2$$

$j = 9, 11, 12, 14, 15, 18, 19, 21, 22, 25, 26, 29, 30, 33, 34, 36, 37, 40, 41, 44,$
45, 48, 49, 52, 53, 56, 57, 60, 61, 64, 65, 67, 68, 71, 72, 75, 76, 79, 80, 83,
84.

$$C3 = \beta3 \oplus [\sum_k b_k] \text{mod } 2$$

$k = 10-12, 16-19, 23-26, 31-34, 38-41, 46-49, 54-57, 62-65, 69-72, 77-80,$
85.

$$C4 = \beta4 \oplus [\sum_l b_l] \text{mod } 2$$

$l = 13-19, 27-34, 42-49, 58-65, 73-80.$

$$C5 = \beta5 \oplus [\sum_m b_m] \text{mod } 2$$

$m = 20-34, 50-65, 81-85.$

$$C6 = \beta6 \oplus [\sum_{n=35}^{65} b_n] \text{mod } 2$$

$$C7 = \beta7 \oplus [\sum_{p=66}^{85} b_p] \text{mod } 2$$

$$C\Sigma = [\sum_{q=1}^8 \beta_q] \text{mod } 2 \oplus [\sum_{q=9}^{85} b_q] \text{mod } 2$$

5 GLONASS SPACE SEGMENT

A structure of GLONASS space segment and orbital parameters of satellites are given in this Section.

5.1 Constellation structure

Completely deployed GLONASS constellation consists of 24 satellites.

Satellites are placed in three orbital planes. There are 8 satellites in each plane. Longitudes of ascending nodes of orbit planes are discriminated on 120° . The orbital planes have ordinal numbers 1, 2 and 3 counting towards Earth rotation. The 1st

orbital plane has slot numbers 1...8, the 2nd orbital plane – slots 9...16, and the 3rd orbital plane – slots 17...24. Slot numbers within orbital plane are increased backward satellite rotation around the Earth.

5.2 Orbital parameters

Nominal values of absolute longitudes of ascending nodes for ideal orbital planes fixed at 00 hours 00 minutes 00 seconds MT (UTC + 03 hours 00 minutes 00 seconds) on January 1st, 1983 are equal to:

$$251^{\circ} 15' 00'' + 120^{\circ} (i - 1),$$

where "i" is orbital plane number (i = 1, 2, 3).

Nominal spacing between adjacent satellites within single orbital plane, according to argument of latitude, is equal to 45°.

Mean rate of orbital plane precession is equal to $(-0.59251 \cdot 10^{-3})$ radian/day.

Ideal values of argument of latitude for satellites located in slots $j = N + 8$ and $j = N + 16$ differ from arguments of latitude for satellites located in slots $j = N$ and $j = N + 8$ by 15° correspondingly, where $N = 1, \dots, 8$. Also make on 0^h00^m00^s on January, 1st, 1983 and are equal to:

$$145^{\circ} 26' 37'' + 15^{\circ} (27 - 3j + 25j^*),$$

(as was fixed at 00 hours 00 minutes 00 seconds MT (UTC + 03 hours 00 minutes 00 seconds on January 1st, 1983)

where: "j" is slot number (j = 1, 2, ..., 24);

$$j^* = E \left\{ \frac{j - 1}{8} \right\} - \text{integer part of } \frac{j - 1}{8}.$$

An interval of repetition for satellite tracks and visibility zones as observed on the ground is equal to 17 orbital periods (7 days 23 hours 27 minutes 28 seconds).

Nominal orbit parameters of the GLONASS system satellites are as follows:

Draconian period - 11 hours 15 minutes 44 seconds;

Orbit altitude - 19100 km;

Inclination - 64.8° ;

Eccentricity - 0.

Maximum deviation of a satellite position relative to ideal slot position does not exceed $\pm 5^{\circ}$ on the period of lifetime.

5.3 Integrity monitoring

The integrity monitoring of GLONASS space segment performance includes checking quality of both characteristics of RF navigation signal and data within navigation message. The monitoring is implemented by two ways.

At first on the GLONASS satellites, there is continuous autonomous operability monitoring of principal onboard systems at each satellite. In case a malfunction is detected that affects quality of navigation signal or navigation data, the "unhealthy" flag appears within immediate information of navigation message. The "unhealthy" flag is transmitted with a period 30 seconds.

Maximum delay from an instant of the malfunction detection to an instant of the "unhealthy" flag generation does not exceed 1 minute for the Glonass-M satellites.

Note: - It is planned to decrease this delay down to 10 seconds by inserting a word l_n to navigation message of GLONASS-M satellite and to increase a update rate of B_n .

At second, a quality of GLONASS space segment performance is monitored using special tracking stations within the ground-based control segment. Another one "unhealthy" flag as a result of this monitoring are generated on the ground and then re-transmitted within non-immediate data of navigation message of all satellites with a period 2.5 minutes. Maximum delay, from an instant of the malfunction detection to an instant of the "unhealthy" flag generation, does not exceed 16 hours.

Thus the following two types of "unhealthy" flag are transmitted within navigation message of GLONASS system satellites:

Tag B_n (l_n):- where "0" indicates the satellite is operational and suitable for navigation;

Tag C_n ($n = 1, \dots, 24$) is "unhealthy" flag that are transmitted within non-immediate data and indicates overall constellation status at the moment of almanac uploading. $C_n = 0$ indicates malfunction of n-satellite. $C_n = 1$ indicates that n-satellite is operational.

GLONASS system users should analyze both B_n (l_n) and C_n flags to take decision on to use or not to use given satellite, as indicated in Table 5.1.

Table 5.1 Health flags B_n (l_n), C_n and operability of satellite

Value of flags		Operability of satellite
B_n (l_n)	C_n	
0	0	-
0	1	+

1	0	-
1	1	-

APPENDIX 1

Received power level in L1 and L2 sub-bands

A guaranteed minimum signal power level Received by a user from "Glonass" and "Glonass-M" (in L1 and L2 sub-bands) is specified in paragraph 3.3.1.6.

Received power level as a function of angle of elevation of satellite for user located on the ground is shown in Fig.A1. The following assumptions were made when drawing the Fig.A1:

- signal power level is measured at output of + 3dBi linearly polarized receiving antenna.;
- angle of elevation of a satellite is at least 5°;
- an atmosphere attenuation is 2dB;
- a satellite angular attitude error is 1° (towards reducing signal power level).

Accuracy of satellite orientation is not worse than $\pm 1^\circ$, but after complete installation of the satellite into his orbital slot.

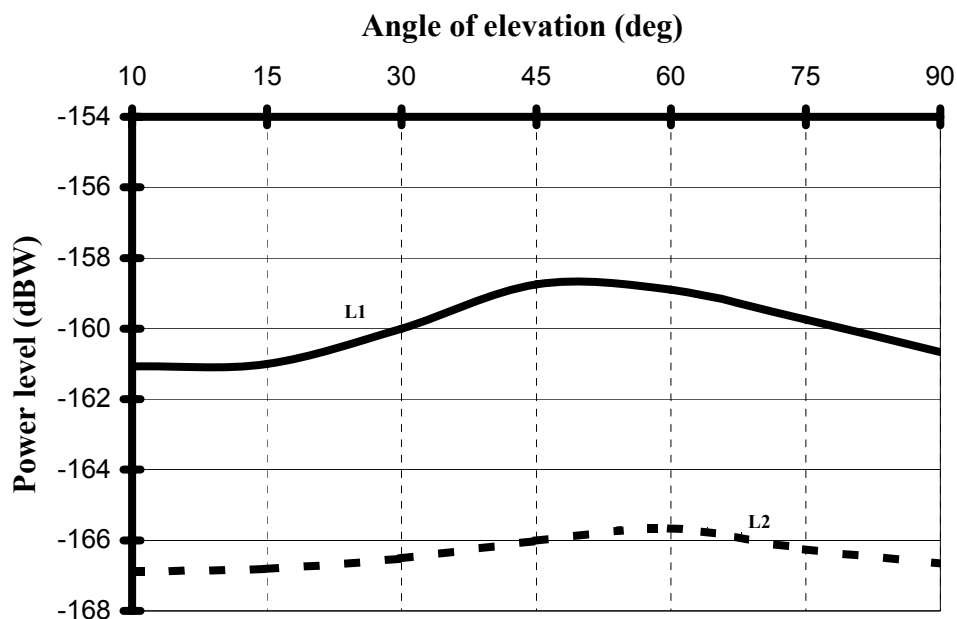

Figure A.1 Relationship between minimum received power level and elevation angle

Higher power level of received signal can be caused by the following reasons:

- deviation (within admissible range) from nominal orbit altitude;
- different values of gain of satellite transmitting antenna in different azimuths and frequency band;
- accuracy of angular orientation of the satellite;
- variations in output signal power due to technological reasons, temperature, voltage and gain variations, and variations in atmospheric attenuation.

It is expected that maximum received power level will not be more than -155.2 dBW provided that user's antenna has above-mentioned characteristics, atmospheric loss is 0.5 dB, and accuracy of angular orientation of a satellite is 1° (towards increasing signal power level).

APPENDIX 2

RECOMMENDATIONS FOR USERS ON OPERATION OF RECEIVER DURING UTC LEAP SECOND CORRECTION

Essential moment of operation of user's receiver upon UTC leap second correction is requirement of simultaneous utilization of UTC_{old} (UTC prior to the correction) and corrected UTC until receiving new ephemeris parameters from all observed GLONASS system satellites.

Upon UTC leap second correction, the receiver should be capable:

- to generate smooth and valid series of pseudorange measurements;
- to re-synchronize the data string time mark without loss of signal tracking.

After the UTC leap second correction, the receiver shall utilize the UTC time as follows:

- utilize old (prior to the correction) UTC time together with the old ephemeris (transmitted before 00 hours 00 minutes 00 seconds UTC);
- utilize the updated UTC time together with the new ephemeris (transmitted after 00 hours 00 minutes 00 seconds UTC).

Into storage of the receiver are inducted from the board or are received from the appropriate navigational message ("Glonass-M or GPS) data about the moment and value of correction UTC.

One second prior to correction UTC in the receiver the check algorithm and usages of corrected system time GLONASS puts into action. The Time slice of operation of the yielded algorithm is stretched:

Till the moment of end of correction of board time scales of all watched SV and hours of the navigational receiver (at a validity check of scaling of measured pseudo-distances);

Till the moment of reception of new ephemerides of all watched SV, that is the ephemerides attributed to an instant $t_b =$ of 00 hours of 15 minutes of 00 seconds, read out on a dial of corrected time UTC (at scaling of ephemerides SV).

For creation of correct meanings of measured distances the receiver should inspect the moments of emanation of displayed signals SV and the moments of their reception. If these events are registered in different time systems (not corrected or corrected time UTC) measured meaning of pseudo-range should be corrected by the correction, equal to meaning of value of correction of time UTC increased by a

velocity of light. Meaning of pseudo-range should be bound (is attributed) to the instant which has been read out on not corrected time scale UTC_{old} .

For scaling of current ephemerises SV «Glonass» up to an instant of reception of new ephemerises the ephemerical data received with SV till the moment of carrying out of correction use. All scalings are carried on in time scale UTC_{old} .

After with next SV new ephemerises will be received, its rule is computed on new ephemerises with usage of corrected time UTC.

Outcomes of the solution of the navigational task and all data worked out by the receiver and given through interfaces after a slaving torque of its hours, should be attributed (are bound) to a dial of corrected time UTC which is implemented by the system time GLONASS shaped in the navigational receiver.

APPENDIX 3

EXAMPLES OF ALGORITHMS FOR CALCULATION OF COORDINATES, VELOCITY AND TRANSFORMATION OF GLONASS-M CURRENT DATA INFORMATION INTO COMMON FORM

The examples of algorithms for calculation of coordinates and velocity of the satellites using ephemeris parameters and almanac are given below.

A.3.1 Example of algorithms for re-calculation of ephemeris to current time

A.3.1.1. Algorithm for re-calculation of ephemeris to current time

Re-calculation of ephemeris from instant t_e to instant t_i within the interval of measurement ($|\tau_i| = |t_i - t_e| < 15$ minutes) is performed using technique of numerical integration of differential equations that describe motion of the satellites. Right-hand parts of these equations take into account the accelerations determined by gravitational constant μ and second zonal coefficient C_{20} , (that characterizes polar flattening of Earth), and accelerations due to lunar-solar gravitational perturbation.

The equations are integrated in direct absolute geocentric coordinate system $Ox_a Y_a Z_a$, connected with current equator and vernal equinox, using 4th order Runge-Kutta technique as indicated below:

$$\begin{aligned} \frac{dx_o}{dt} &= Vx_o \quad , \\ \frac{dy_o}{dt} &= Vy_o \quad , \\ \frac{dz_o}{dt} &= Vz_o \quad , \\ \frac{dVx_o}{dt} &= -\mu \bar{x}_o + \frac{3}{2} C_{20} \mu \bar{x}_o \rho^2 (1 - 5\bar{z}_o^2) + j_{x_o c} + j_{x_o l} \quad , \quad (1) \\ \frac{dVy_o}{dt} &= -\mu \bar{y}_o + \frac{3}{2} C_{20} \mu \bar{y}_o \rho^2 (1 - 5\bar{z}_o^2) + j_{y_o c} + j_{y_o l} \quad , \\ \frac{dVz_o}{dt} &= -\mu \bar{z}_o + \frac{3}{2} C_{20} \mu \bar{z}_o \rho^2 (3 - 5\bar{z}_o^2) + j_{z_o c} + j_{z_o l} \quad . \end{aligned}$$

where

$$\bar{\mu} = \frac{\mu}{r^2} \quad , \quad \bar{x}_o = \frac{x_o}{r} \quad , \quad \bar{y}_o = \frac{y_o}{r_o} \quad , \quad \bar{z}_o = \frac{z_o}{r_o} \quad , \quad \rho = \frac{a_e}{r_o} \quad ,$$

$$r_o = \sqrt{x_o^2 + y_o^2 + z_o^2} \quad ,$$

$j_{x_o c}$, $j_{y_o c}$, $j_{z_o c}$ - Accelerations due to solar gravitational perturbation;

$j_{x_{\omega L}}, j_{y_{\omega L}}, j_{z_{\omega L}}$ - Accelerations due to lunar gravitational perturbations;

a_e - Equatorial radius of Earth, 6378.136 km;

μ - Gravitational constant, (398600.44 km³/s²);

C_{20} - Second zonal coefficient of spherical harmonic expansion,

(-1082.63*10⁻⁶); ($C_{20} = \sqrt{5} * \bar{C}_{20}$, where \bar{C}_{20} – normalized value of harmonic coefficient (-484.165*10⁻⁶)).

Accelerations due to both lunar and solar perturbations are computed using the following formulae:

$$\begin{aligned} j_{x_{oK}} &= \bar{\mu}_K \left[(\xi_{o_{K\Theta}} - \bar{x}_{o_K}) \Delta_{o_K}^{-3} - \xi_{o_{K\Theta}} \right], \\ j_{y_{oK}} &= \bar{\mu}_K \left[(\eta_{o_{K\Theta}} - \bar{y}_{o_K}) \Delta_{o_K}^{-3} - \eta_{o_{K\Theta}} \right], \\ j_{z_{oK}} &= \bar{\mu}_K \left[(\zeta_{o_{K\Theta}} - \bar{z}_{o_K}) \Delta_{o_K}^{-3} - \zeta_{o_{K\Theta}} \right], \end{aligned} \quad (2)$$

где:

$$\begin{aligned} \bar{\mu}_K &= \frac{\mu_K}{r_{o_{K\Theta}}^2}, \quad \bar{x}_{o_K} = \frac{x_o}{r_{o_{K\Theta}}}, \quad \bar{y}_{o_K} = \frac{y_o}{r_{o_{K\Theta}}}, \quad \bar{z}_{o_K} = \frac{z_o}{r_{o_{K\Theta}}}, \\ \Delta_{o_K}^2 &= (\xi_{o_{K\Theta}} - \bar{x}_{o_K})^2 + (\eta_{o_{K\Theta}} - \bar{y}_{o_K})^2 + (\zeta_{o_{K\Theta}} - \bar{z}_{o_K})^2, \end{aligned}$$

κ – Index for a perturbing body; $\kappa = m$ indicates “lunar”, and $\kappa = s$ indicates “solar”;

$\xi_{o_{K\Theta}}, \eta_{o_{K\Theta}}, \zeta_{o_{K\Theta}}, r_{o_{K\Theta}}$ – Directive cosines and radius-vector of perturbing bodies in $Ox_a Y_a Z_a$ coordinate system at instant t_e

μ_m – Lunar gravitational constant ($4902.835 \text{ km}^3/\text{s}^2$);

μ_s – Solar gravitational constant ($0.1325263 * 10^{12} \text{ km}^3/\text{s}^2$).

The parameters $\xi_k, \eta_k, \zeta_k, r_k$ from equations (2) are computed (at instant t_e) once per interval (± 15 minutes) using the following formulae [Duboshin G.N., Celestial Mechanics, M. "Nauka", 1975; Abalakin V.K., Principles of ephemeris astronomy, M., "Nauka", 1979]:

$$\begin{aligned}
 \xi_{l\vartheta} &= \sin(\vartheta_l + \Gamma')\xi_{11} + \cos(\vartheta_l + \Gamma')\xi_{12} \quad , \\
 \eta_{l\vartheta} &= \sin(\vartheta_l + \Gamma')\eta_{11} + \cos(\vartheta_l + \Gamma')\eta_{12} \quad , \\
 \zeta_{l\vartheta} &= \sin(\vartheta_l + \Gamma')\zeta_{11} + \cos(\vartheta_l + \Gamma')\zeta_{12} \quad , \\
 \xi_{c\vartheta} &= \cos \vartheta_c \cdot \cos \omega_c - \sin \vartheta_c \cdot \sin \omega_c, \\
 \eta_{c\vartheta} &= (\sin \vartheta_c \cdot \cos \omega_c + \cos \vartheta_c \cdot \sin \omega_c) \cos \varepsilon, \\
 \zeta_{c\vartheta} &= (\sin \vartheta_c \cdot \cos \omega_c + \cos \vartheta_c \cdot \sin \omega_c) \sin \varepsilon, \\
 r_{k\vartheta} &= a_k \cdot (1 - e_k \cos E_k) \quad , \quad (k = l, c) \quad ,
 \end{aligned} \tag{3}$$

where

$$\begin{aligned}
 E_k &= q_k + e_k \cdot \sin E_k \quad , \\
 \sin \vartheta_k &= \sqrt{1 - e_k^2} \sin E_k (1 - e_k \cos E_k)^{-1}, \\
 \cos \vartheta_k &= (\cos E_k - e_k)(1 - e_k \cos E_k)^{-1} \quad , \\
 \xi_{11} &= \sin \Omega_l \cdot \cos \Omega_l (1 - \cos i_l), \\
 \xi_{12} &= 1 - \sin^2 \Omega_l (1 - \cos i_l), \\
 \eta_{11} &= \xi^* \cos \varepsilon - \zeta^* \sin \varepsilon, \\
 \eta_{12} &= \xi_{11} \cos \varepsilon + \eta^* \sin \varepsilon, \\
 \zeta_{11} &= \xi^* \sin \varepsilon + \zeta^* \cos \varepsilon, \\
 \zeta_{12} &= \xi_{11} \sin \varepsilon + \eta^* \cos \varepsilon, \\
 \xi^* &= 1 - \cos^2 \Omega_l (1 - \cos i_l), \\
 \eta^* &= \sin \Omega_l \cdot \sin i_l \quad , \\
 \zeta^* &= \cos \Omega_l \cdot \sin i_l \quad , \\
 q_k &= q_{OK} + q_{1K} \cdot T \quad , \\
 \Omega_l &= \Omega_{Ol} + \Omega_{1l} \cdot T \quad , \\
 \Gamma' &= \Gamma'_0 + \Gamma'_1 \cdot T, \\
 T &= (27392,375 + \Sigma_{\partial H} + t_{\vartheta} \cdot 86400^{-1}) \cdot 36525^{-1}.
 \end{aligned}$$

Where:

a_l - Semi-major axis of lunar orbit ($3.84385243 \cdot 10^5$ km);

a_c - Semi-major axis of solar "orbit" ($1.49598 \cdot 10^8$ km);

e_l - Eccentricity of lunar orbit (0.054900489)

e_c - Eccentricity of solar orbit (0.016719);

i_l - Inclination of lunar orbit to ecliptic plane ($5^\circ 08' 43.4''$);;

ε - Mean inclination of ecliptic to equator ($23^\circ 26' 33''$);;

$q_{0\pi} = -63^\circ 53' 43'', 41$;

$q_{1\pi} = 477198^\circ 50' 56'', 79$;

$\Omega_{0\pi} = 259^\circ 10' 59'', 79$;

$\Omega_{1\pi} = -1934^\circ 08' 31'', 23$;

$\Gamma'_0 = -334^\circ 19' 46'', 40$;

$\Gamma'_1 = 4069^\circ 02' 02'', 52$;

$\omega_c = 281^\circ 13' 15'', 0 + 6189'', 03T$;

$q_{0c} = 358^\circ 28' 33'', 04$;

$q_{1c} = 129596579'', 10$;

T is a time from the epoch 5 January 1900 (GMT) to time reference t_e of ephemeris parameters (in Julian centuries of 36525 ephemeris days);

27392.375 is a number of days from the epoch 5 January 1900 to the epoch 0 January 1975 (Moscow Time or MT) taking into account the three-hour offset between MT and GMT when re-computing t_e into GMT;

Σ_{days} - sum of days from the epoch at 00 hours MT on 0 January 1975 to the epoch at 00 hours MT of current date within which the instant t_e is.

Coordinates $X(t_e)$, $Y(t_e)$, $Z(t_e)$ and velocity vector components $V_x(t_e)$, $V_y(t_e)$, $V_z(t_e)$ are initial conditions for integration of the system (1); they are taken from a navigation message and then re-computed from Greenwich coordinate system (PZ-90.02) to an absolute coordinate system $OX_a Y_a Z_a$ using the following formulae:

$$X_o(t_e) = x(t_e) \cos S(t_e) - y(t_e) \sin S(t_e),$$

$$Y_o(t_e) = x(t_e) \sin S(t_e) + y(t_e) \cos S(t_e),$$

$$Z_o(t_e) = z(t_e),$$

$$V_{X_o}(t_e) = V_x(t_e) \cos S(t_e) - V_y(t_e) \sin S(t_e) - \omega_3 Y_o(t_e),$$

$$V_{Y_o}(t_e) = V_x(t_e) \sin S(t_e) + V_y(t_e) \cos S(t_e) + \omega_3 X_o(t_e),$$

$$V_{Z_o}(t_e) = V_z(t_e),$$

$$S(t_e) = s + \omega_3 (t_e - 3^h)$$

Where:

ω_E - Earth's rotation rate ($0.7292115 \cdot 10^{-4} \text{ s}^{-1}$);

s - true sidereal time at midnight GMT of a date within which the instant t_e is specified.

After integration received in an absolute system of units of co-ordinates $OX_0Y_0Z_0$ of co-ordinate $X_o(t_i)$, $Y_o(t_i)$, $Z_o(t_i)$ and components of velocity vector of space vehicle $V_{x_o}(t_i)$, $V_{y_o}(t_i)$, $V_{z_o}(t_i)$ can be translated in an earth-referenced Greenwich geocentric conception of co-ordinates ПЗ-90-02 $Oxyz$ under formulas:

$$\begin{aligned}x(t_i) &= X_o(t_i) \cos S(t_i) + Y_o(t_i) \sin S(t_i), \\y(t_i) &= -X_o(t_i) \sin S(t_i) + Y_o(t_i) \cos S(t_i), \\z(t_i) &= Z_o(t_i), \\V_x(t_i) &= V_{x_o}(t_i) \cos S(t_i) + V_{y_o}(t_i) \sin S(t_i) + \omega_3 Y(t_i), \\V_y(t_i) &= -V_{x_o}(t_i) \sin S(t_i) + V_{y_o}(t_i) \cos S(t_i) - \omega_3 X(t_i), \\V_z(t_i) &= V_{z_o}(t_i), \\S(t_i) &= s + \omega_3 (t_i - 3^h).\end{aligned}$$

Notes:

Accelerations $J_{x_{as}}$, $J_{x_{am}}$, $J_{y_{as}}$, $J_{y_{am}}$, $J_{z_{as}}$, $J_{z_{am}}$ in equation (1) can be either adopted constant and computed once per an instant t_e using the formulae (2) or excluded from (1) and then added the results of integration of corrections:

$$\begin{aligned}\Delta X &= (J_{x_{am}} + J_{x_{as}}) * \tau^2/2, \quad \Delta Y = (J_{y_{am}} + J_{y_{as}}) * \tau^2/2, \quad \Delta Z = (J_{z_{am}} + J_{z_{as}}) \tau^2/2, \\ \Delta V_x &= (J_{x_{am}} + J_{x_{as}}) * \tau, \quad \Delta V_y = (J_{y_{am}} + J_{y_{as}}) * \tau, \quad \Delta V_z = (J_{z_{am}} + J_{z_{as}}) \tau,\end{aligned}$$

where $\tau = t_i - t_e$.

2. Directive cosines ξ_k , η_k , ζ_k can be computed using the formulae (3) or taken from an external source.

The origin of Greenwich (right-hand) coordinate system is in the center of Earth's body; OZ-axis is directed to northern pole along Earth's rotation axis; OX- axis is directed to the point of intersection of Greenwich meridian and equatorial plane.

If to exclude lunar-solar accelerations when integrating system (1) and take into them account by addition of them to the results of integration

$$\Delta X = (J_{x_{am}} + J_{x_{as}}) * \tau^2/2, \quad \Delta Y = (J_{y_{am}} + J_{y_{as}}) * \tau^2/2, \quad \Delta Z = (J_{z_{am}} + J_{z_{as}}) \tau^2/2,$$

$$\Delta V_x = (J_{X_a m} + J_{X_a s}) * \tau, \quad \Delta V_y = (J_{y_a m} + J_{y_a s}) * \tau, \quad \Delta V_z = (J_{z_a m} + J_{z_a s}) \tau,$$

then increasing, due to this, of ephemeris extrapolation errors does not exceed 10%. Here $(J_{X_a m} + J_{X_a s})$, $(J_{y_a m} + J_{y_a s})$, $(J_{z_a m} + J_{z_a s})$ are projection of lunar-solar accelerations to axes of $O X_a Y_a Z_a$ system at instant t_e to which ephemeris parameters are referenced, they are computed using the formulae (2).

To calculate ephemeris parameters at instant t_j the projections of lunar-solar accelerations to axes of Greenwich geocentric coordinate system $X''(t_e)$, $Y''(t_e)$, $Z''(t_e)$ can be used; they are transmitted within navigation message. Prior to the integration of the system (1) these accelerations should be transformed into an absolute Cartesian geocentric coordinate system $O X_a Y_a Z_a$ using the following formulae:

$$\begin{aligned} (J_{X_a m} + J_{X_a s}) &= X''(t_e) * \cos S - Y''(t_e) * \sin S, \\ (J_{y_a m} + J_{y_a s}) &= X''(t_e) * \sin S + Y''(t_e) * \cos S, \\ (J_{z_a m} + J_{z_a s}) &= Z''(t_e) \end{aligned}$$

An accuracy of ephemeris data multiplication is given in the following table:

Step of integration, minutes	Interval of integration		
	5 minutes	10 minutes	15 minutes
1	0.42	0.56	0.77
2.5	0.42	0.56	0.77
5	0.45	0.61	0.83
7.5	-	-	1.21

A.3.1.2. Simplify of algorithm for re-calculation of ephemeris to current time

Re-calculation of ephemeris within the interval of measurement is performed using technique of numerical integration of differential equations that describe motion of the satellites in coordinate system PZ -90.02:

$$dx / dt = V_x$$

$$dy / dt = V_y$$

$$dz / dt = V_z$$

$$dV_x / dt = -\frac{\mu}{r^3} x - \frac{3}{2} J_0^2 \frac{\mu a_e^2}{r^5} x \left(1 - \frac{5z^2}{r^2} \right) + \omega^2 x + 2\omega V_y + \ddot{x}$$

$$dV_y / dt = -\frac{\mu}{r^3} y - \frac{3}{2} J_0^2 \frac{\mu a_e^2}{r^5} y \left(1 - \frac{5z^2}{r^2} \right) + \omega^2 y + 2\omega V_x + \ddot{y}$$

$$dV_z / dt = -\frac{\mu}{r^3} z - \frac{3}{2} J_0^2 \frac{\mu a_e^2}{r^5} z \left(1 - \frac{5z^2}{r^2} \right) + \ddot{z}$$

where:

$$r = \sqrt{x^2 + y^2 + z^2};$$

$\mu = 398600.44 \cdot 10^9 \text{ m}^3 / \text{s}^2$ - Gravitational constant;

$a_e = 6\,378\,136 \text{ m}$ - Semi-major axis of Earth ;

$J_0 = 1082625.7 \cdot 10^{-9}$ - Second zonal harmonic of the geopotential;

$\omega = 7.292115 \cdot 10^{-5} \text{ radian/s}$ - Earth rotation rate.

Initial conditions of integration of reduced equations set are co-ordinates and components of velocity vector of n th SV $x_n(t_b), y_n(t_b), z_n(t_b), x'_n(t_b) = V_x, y'_n(t_b) = V_y, z'_n(t_b) = V_z$.

Accelerations due to lunar-solar gravitational perturbation $\ddot{x}_n(t_b), \ddot{y}_n(t_b), \ddot{z}_n(t_b)$ are constant in the integration interval ± 15 minutes.

A.3.1.3. Transformation of GLONASS-M current data information into common form

Satellite navigation message contains current data information in N_T parameter. It could be transformed into the common form by the following algorithm:

1). Current year number **J** in the four-year interval is calculated:

If $1 \leq N_T \leq 366$; $J = 1$;

If $367 \leq N_T \leq 731$; $J = 2$;

If $732 \leq N_T \leq 1096$; $J = 3$;

If $1097 \leq N_T \leq 1461$; $J = 4$.

2). Current year in common form is calculated by the following formula:

$$Y = 1996 + 4*(N_4 - 1) + (J - 1).$$

3). Current day and month (dd/mm) are extracted from the reference table stored in user equipment ROM. The table interrelates NT parameter and common form dates.

For example, meaning $N_T = 839$ then according to algorithm point 1 we discover meaning J, it will be equal 3.

Further from a navigational frame we take meaning N_4 , we will accept it equally 2.

And now we compute a value Y - current year in the conventional form:

$$Y = 1996 + 4 * (2 - 1) + (3 - 1) = 1996 + 4 * 1 + 2 = 1996 + 4 + 2 = 2002$$

A.3.2 Algorithm of calculation of satellite motion parameters using almanac

The algorithm is used when selecting optimal constellation, calculating satellite position to provide acquisition and tracking the selected satellite. The algorithm allows calculating the coordinates and velocity vector components of a satellite at instant of acquisition t_i

A.3.2.1 Almanac data

GLONASS almanac contains orbital parameters specified for each satellite at an instant t_{λ_j}

A list of the parameters for each satellite is as indicated below:

- N_{A_j} - Calendar number of a day within four-year interval starting from latest leap year; almanac data for j -satellite are referenced to N_{A_j} ;
- λ_j - Greenwich longitude of ascending node of orbit of j -satellite at instant t_{λ_j} (in radians);
- t_{λ_j} - An instant of a first ascending node passage of j -satellite within N_{A_j} – day (in seconds);
- Δi_j - Correction to the mean value of inclination of j -satellite at instant t_{λ_j} (mean value of inclination is equal to 63°);
- ΔT_j - Correction to the mean value of Draconian period of j -satellite at instant t_{λ_j} (mean value of Draconian period T is equal to 43200 seconds);
- $\Delta T'_j$ - Rate of change of orbital period for j -satellite;
- ε_j - Eccentricity of j -satellite orbit at instant t_{λ_j} ;
- ω_j - Argument of perigee of j -satellite orbit at instant t_{λ_j} (in radians).

λ - Index of an accessory of parameters AC By time of passing of an ascending node of an orbit t_{λ_j} , and j - number SV ($j = 1, \dots, 24$). Further the index j is omitted.

Average values of obliquity of orbital plane SV GLONASS system i_{cp} a period of revolution T_{cp} . Make 63° and 43200 with, accordingly.

The gang of orbit parameters for everyone SV is set in the Greenwich geocentric conception of co-ordinates OXYZ "frozen" during the moment t_{λ} .

The system beginning is combined with a centre of mass of the Earth. The Z-axis is routed to a mean northern pole for a mean epoch of 1900-1905 of, shaft OX lies in a plane of terrestrial equator of an epoch of 1900-1905 of, plane XOZ is thus parallel to mean Greenwich meridian and determines a rule of a zero-mark of the count system of longitudes, shaft OY adds system to the right.

A.3.2.2 Algorithm of calculation

Calculation of satellite and velocity vector components at instant t_i (MT) of a day N_0 within four-year interval, and in absolute geocentric coordinate system $OX_a Y_a Z_a$ (which origin and Z -axis coincide with origin and Z -axis of $OXYZ$ system, offset between XOZ -plane and $X_a OZ_a$ is equal to true sidereal time, and OY_a - axis completes the system to the right-handed one) is performed in two steps.

At the first step the time t_k of ascending node passage at k -orbital period and corresponding longitude λ_k are calculated using the almanac parameters ΔT , $\Delta T'$ and λ . Here the specified instant t_i is within the following interval: $(t_i - t_k < T_{\text{mean}} + \Delta T)$. Other parameters are assumed constant and equal to the corresponding parameters of almanac.

Then osculating elements are re-computed from the instant t_k to the instant t_i using analytic formulae and taking into account secular and periodic perturbations of the orbital elements caused by second zonal harmonic C_{20} .

Then the osculating elements at instant t_i are transformed into kinematic parameters, as indicated below.

semi-major axis "a" of orbit is calculated using technique of successive approximations:

$$a^{(n+1)} = \sqrt[3]{\left(\frac{T_{\text{ock}}^{(n+1)}}{2\pi}\right)^2 \cdot \mu} ,$$

$$T_{\text{ock}}^{(n+1)} = T_{\text{op}} \cdot \left\{ 1 + \frac{3}{2} \cdot C_{20} \left(\frac{a_e}{p^{(n)}}\right)^2 \left[\left(2 - \frac{5}{2} \cdot \sin^2 i\right) \cdot \frac{(1-e^2)^{3/2}}{(1+e \cdot \cos \omega)^2} + \frac{(1+e \cdot \cos \omega)^3}{1-e^2} \right] \right\}^{-1} ,$$

$$p^{(n)} = a^{(n)} \cdot (1 - e^2) , \quad n = 0, 1, 2, \dots ,$$

where $\nu = -\omega$, $i = i_{\text{cp}} + \Delta i$ and $T_{\text{dp}} = T_{\text{cp}} + \Delta T$.

An initial approximation $a^{(0)} = \sqrt[3]{\left(\frac{T_{\text{op}}}{2\pi}\right)^2 \mu}$.

The process of approximation ends when fulfilling the following condition:

$$|a^{(n+1)} - a^{(n)}| < 10^{-3} \text{ км} .$$

Usually it is enough to make three iterations for it.

The time t_k of ascending node passage on k -orbital period (within which the instant t_i is located) and respective longitude λ_k are calculated:

$$t_{\lambda k} = [\overline{t_{\lambda k}}]_{\text{mod } 86400} ,$$

$$\overline{t_{\lambda k}} = t_{\lambda} + T_{\text{op}} \cdot W + \Delta T' \cdot W^2 ,$$

$$W_k = \frac{t^*}{T_{\text{op}}} , \quad W - \text{hole part } W_k ,$$

$$\begin{aligned}
t^* &= t_i - t_{\lambda} + 86400 \cdot (N_0 - N_A), \\
\lambda_k &= \lambda + (\Omega' - \omega_3) \cdot (T_{op} \cdot W + \Delta T' \cdot W^2), \\
\Omega' &= \frac{3}{2} C_{20} \cdot n \cdot \left(\frac{a_e}{a}\right)^2 \cdot \cos i \cdot (1 - e^2)^2, \\
n &= \frac{2\pi}{T_{op}}, \\
\Omega &= \lambda_k + S, \\
S &= S_0 + \omega_3 \cdot (t_{\lambda k} - 10800).
\end{aligned}$$

Where:

C_{20} – Second zonal harmonic of geopotential ($-1082.63 \cdot 10^{-6}$);

a_e – Equatorial radius of Earth (6378.136 km);

S_0 – True sidereal time at Greenwich midnight on day N_0 , within which the instant t_i is located;

ω_3 – Earth's rotation rate ($0.7392115 \cdot 10^{-4} \text{ s}^{-1}$);

μ – Gravitational constant ($398600.44 \text{ km}^3 / \text{s}^2$).

3) Constant parameters of integration at the instant $t_{\lambda k}$ are computed:

$$\begin{aligned}
\frac{\delta a^{(m)}}{a} &= 2J\left(\frac{a_e}{a}\right)^2 \left(1 - \frac{3}{2} \sin^2 i\right) (l \cdot \cos \bar{\lambda} + h \cdot \sin \bar{\lambda}) + J\left(\frac{a_e}{a}\right)^2 \sin^2 i \cdot \\
&\left(\frac{1}{2} h \cdot \sin \bar{\lambda} - \frac{1}{2} l \cdot \cos \bar{\lambda} + \cos 2\bar{\lambda} + \frac{7}{2} l \cdot \cos 3\bar{\lambda} + \frac{7}{2} h \cdot \sin 3\bar{\lambda}\right), \\
\delta h^{(m)} &= J\left(\frac{a_e}{a}\right)^2 \left(1 - \frac{3}{2} \sin^2 i\right) \left[l \cdot n \cdot \tau + \sin \bar{\lambda} + \frac{3}{2} l \cdot \sin 2\bar{\lambda} - \frac{3}{2} h \cdot \cos 2\bar{\lambda}\right] - \\
&\frac{1}{4} J\left(\frac{a_e}{a}\right)^2 \sin^2 i \left[\sin \bar{\lambda} - \frac{7}{3} \sin 3\bar{\lambda} + 5l \cdot \sin 2\bar{\lambda} - \frac{17}{2} l \cdot \sin 4\bar{\lambda} + \frac{17}{2} h \cdot \cos 4\bar{\lambda} + h \cdot \cos 2\bar{\lambda}\right] + \\
&J\left(\frac{a_e}{a}\right)^2 \cos^2 i \left(l \cdot n \cdot \tau - \frac{1}{2} l \cdot \sin 2\bar{\lambda}\right), \\
\delta l^{(m)} &= J\left(\frac{a_e}{a}\right)^2 \left(1 - \frac{3}{2} \sin^2 i\right) \left[-h \cdot n \cdot \tau + \cos \bar{\lambda} + \frac{3}{2} l \cdot \cos 2\bar{\lambda} + \frac{3}{2} h \cdot \sin 2\bar{\lambda}\right] - \\
&\frac{1}{4} J\left(\frac{a_e}{a}\right)^2 \sin^2 i \left[-\cos \bar{\lambda} - \frac{7}{3} \cos 3\bar{\lambda} - 5h \cdot \sin 2\bar{\lambda} - \frac{17}{2} l \cdot \cos 4\bar{\lambda} - \frac{17}{2} h \cdot \sin 4\bar{\lambda} + l \cdot \cos 2\bar{\lambda}\right] + \\
&J\left(\frac{a_e}{a}\right)^2 \cos^2 i \left(-h \cdot n \cdot \tau + \frac{1}{2} h \cdot \sin 2\bar{\lambda}\right) \\
\delta \Omega^{(m)} &= -J\left(\frac{a_e}{a}\right)^2 \cos i \left(n \cdot \tau + \frac{7}{2} l \cdot \sin \bar{\lambda} - \frac{5}{2} h \cdot \cos \bar{\lambda} - \frac{1}{2} \sin 2\bar{\lambda} - \frac{7}{6} l \cdot \sin 3\bar{\lambda} + \frac{7}{6} h \cdot \cos 3\bar{\lambda}\right), \\
\delta i^{(m)} &= \frac{1}{2} J\left(\frac{a_e}{a}\right)^2 \sin i \cdot \cos i \left(-l \cdot \cos \bar{\lambda} + h \cdot \sin \bar{\lambda} + \cos 2\bar{\lambda} + \frac{7}{3} l \cdot \cos 3\bar{\lambda} + \frac{7}{3} h \cdot \sin 3\bar{\lambda}\right),
\end{aligned}$$

$$\begin{aligned} \delta \bar{\lambda}^{(m)} = & 2J \left(\frac{a_e}{a} \right)^2 \left(1 - \frac{3}{2} \sin^2 i \right) \left(n \cdot \tau + \frac{7}{4} l \cdot \sin \bar{\lambda} - \frac{7}{4} h \cdot \cos \bar{\lambda} \right) + 3J \left(\frac{a_e}{a} \right)^2 \sin^2 i \cdot \\ & \left(-\frac{7}{24} h \cdot \cos \bar{\lambda} - \frac{7}{24} l \cdot \sin \bar{\lambda} - \frac{49}{72} h \cdot \cos 3\bar{\lambda} + \frac{49}{72} l \cdot \sin 3\bar{\lambda} + \frac{1}{4} \sin 2\bar{\lambda} \right) + J \left(\frac{a_e}{a} \right)^2 \cos^2 i \cdot \\ & \left(n \cdot \tau + \frac{7}{2} l \cdot \sin \bar{\lambda} - \frac{5}{2} h \cdot \cos \bar{\lambda} - \frac{1}{2} \sin 2\bar{\lambda} - \frac{7}{6} l \cdot \sin 3\bar{\lambda} + \frac{7}{6} h \cdot \cos 3\bar{\lambda} \right), \end{aligned} \quad (1)$$

where: $\bar{\lambda} = M + \omega$, $M = E - e \sin E$, $\operatorname{tg} \frac{E}{2} = \sqrt{\frac{1-e}{1+e}} \operatorname{tg} \frac{\nu}{2}$,

$h = e \sin \omega$, $l = e \cos \omega$, $m=1$, $\tau = 0$, $J = -\frac{3}{2} C_{20}$, $a = a^{(n)}$ (1).

4) Corrections to orbital elements at instant t_i due to effect of C_{20} are computed:

$$\begin{aligned} \delta a &= \delta a^{(2)} - \delta a^{(1)}, & \delta \Omega &= \delta \Omega^{(2)} - \delta \Omega^{(1)}, \\ \delta h &= \delta h^{(2)} - \delta h^{(1)}, & \delta \dot{\mathbf{i}} &= \delta \dot{\mathbf{i}}^{(2)} - \delta \dot{\mathbf{i}}^{(1)}, \\ \delta l &= \delta l^{(2)} - \delta l^{(1)}, & \delta \lambda^* &= \delta \bar{\lambda}^{(2)} - \delta \bar{\lambda}^{(1)}. \end{aligned}$$

Parameters $\delta a^{(2)}, \delta h^{(2)}, \delta l^{(2)}, \delta \Omega^{(2)}, \delta \dot{\mathbf{i}}^{(2)}$ and $\delta \bar{\lambda}^{(2)}$ are computed for $\tau = t_i - t_{\lambda k}$ and $m=2$ using the formulae (1), where $\bar{\lambda} = M + \omega + n \cdot \tau$.

Perturbing orbital elements of satellites at instant t_i are computed:

$$\begin{aligned} h_i &= h + \delta h, \\ l_i &= l + \delta l, \\ \varepsilon_i &= \sqrt{h_i^2 + l_i^2}, \\ \omega_i &= \begin{cases} \arctg\left(\frac{h_i}{l_i}\right), & \text{and } \varepsilon_i \neq 0 \text{ and } l_i \neq 0, \\ 0, & \text{and } \varepsilon_i = 0, \\ \frac{\pi}{2}, & \text{and } \varepsilon_i \neq 0 \text{ and } h_i = \varepsilon_i, \\ -\frac{\pi}{2}, & \text{if } \varepsilon_i \neq 0 \text{ and } h_i = -\varepsilon_i, \end{cases} \end{aligned}$$

$$a_i = a + \delta a,$$

$$i_i = i + \delta i,$$

$$\Omega_i = \Omega + \delta \Omega,$$

$$M_i = \lambda^* - \omega_i, \quad \lambda^* = M + \omega + n \cdot (t_i - t_{\lambda k}) + \delta \lambda^*.$$

Here "i" indicates reference to instant t_i ,

Coordinates and velocity vector components at instant t_i in OX_aY_aZ_a coordinate system are computed:

$$E_i^{(n)} = M_i + \varepsilon_i \sin E_i^{(n-1)},$$

$$E_i^{(0)} = M_i,$$

$$|E_i^{(n)} - E_i^{(n-1)}| < 10^{-8},$$

$$\operatorname{tg} \frac{\nu_i}{2} = \sqrt{\frac{1 + \varepsilon_i}{1 - \varepsilon_i}} \cdot \operatorname{tg} \frac{E_i^{(n)}}{2},$$

$$\mathbf{u}_i = \nu_i + \omega_i,$$

$$r_i = a_i (1 - \varepsilon_i \cos E_i^{(n)}),$$

$$Vr_i = \sqrt{\frac{\mu}{a_i}} \cdot \frac{\varepsilon_i \sin \nu_i}{\sqrt{1 - \varepsilon_i^2}},$$

$$Vu_i = \sqrt{\frac{\mu}{a_i}} \cdot \frac{1 + \varepsilon_i \cos \nu_i}{\sqrt{1 - \varepsilon_i^2}},$$

$$X_{oi} = r_i (\cos u_i \cdot \cos \Omega_i - \sin u_i \cdot \sin \Omega_i \cdot \cos i_i),$$

$$Y_{oi} = r_i (\cos u_i \cdot \sin \Omega_i + \sin u_i \cdot \cos \Omega_i \cdot \cos i_i),$$

$$Z_{oi} = r_i \cdot \sin u_i \cdot \sin i_i,$$

$$Vx_{oi} = Vr_i (\cos u_i \cdot \cos \Omega_i - \sin u_i \cdot \sin \Omega_i \cdot \cos i_i) - Vu_i (\sin u_i \cdot \cos \Omega_i + \cos u_i \cdot \sin \Omega_i \cdot \cos i_i),$$

$$Vy_{oi} = Vr_i (\cos u_i \cdot \sin \Omega_i + \sin u_i \cdot \cos \Omega_i \cdot \cos i_i) - Vu_i (\sin u_i \cdot \sin \Omega_i - \cos u_i \cdot \cos \Omega_i \cdot \cos i_i),$$

$$Vz_{oi} = Vr_i \cdot \sin u_i \cdot \sin i_i + Vu_i \cdot \cos u_i \cdot \sin i_i.$$

A 3.2.3 the Instance of calculation of co-ordinates and components of velocity vector SV according to system GLONASS almanac

1) AC SV of system GLONASS Is set:

N_{Aj}	=	615	Date 06.09.2001
λ_j	=	-0.189986229	Half cycle
t_{Aj}	=	27122.09375	seconds
Δi_j	=	0.011929512	Half cycle
ΔT_j	=	-2655.76171875	seconds
$\Delta T'_j$	=	0.000549316	Secjnds/cycle ²
ε_j	=	0.001482010	
ω_j	=	0.440277100	Half cycle

It is necessary to calculate co-ordinates and components of velocity vector in co-ordinate system $Ox_oY_oZ_o$ on an instant:

N_{Aj}	=	615	date 06.09.2001
t_{Aj}	=	33300. seconds	$S_0 = 6.02401539573$ rad

Outcome: Coordinates and components of velocity vector SV in co-ordinate system $Ox_oY_oZ_o$ on an instant t_{Aj} dates N_{Aj} :

X_{oi}	=	10947.021572	km
Y_{oi}	=	13078.978287	km
Z_{oi}	=	18922.063362	km
$V_{x_{oi}}$	=	-3.375497	m/s
$V_{y_{oi}}$	=	-0.161453	Km/s
$V_{z_{oi}}$	=	2.060844	Km/s

Numbers of pages / numbers of partitions				In total pages in doc.	number deed	Entering № the Covering note doc. And date	Signat ure	Date
changed	substitute d	new	except ed					
Partitions: Signature lists; Section 2; Section 3.3.1.2; Section 3.3.3; Section 3.3.4; 3 application				75				

On all problems linked with ICD of GLONASS system, you can revert in the Russian institute of space device engineering.

e-mail: contact@rniikp.ru

Internet: <http://www.rniikp.ru>